

ME23300

Ø 31.50 / 31.50 x 31.50 H13.75

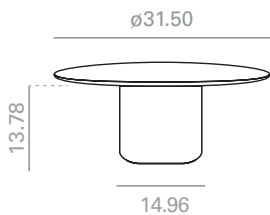

Top shape

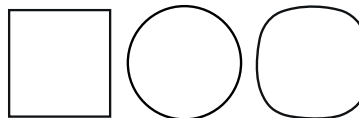

Square Round Ellipse

	Table top / Sobre				
	*Oak Roble	Lacquered Lacado	***M1 Marble M1	***M2 Marble M2	Compacto HPL
	\$	\$	\$	\$	\$
	2,114	1,857	3,887	4,736	1,681
lbs	0	0	0	0	0
1 box / bulto Ft	11'25	11'25	18'5	18'5	11'25

	Table top / Sobre				
	Compacto HPL Decorative	Compacto HPL Premium	Technical Stone 8	Technical Stone 8 Premium	Solid Surface
	\$	\$	\$	\$	\$
	1,854	2,026	3,163	3,363	2,824
lbs	0	0	0	0	0
1 box / bulto Ft	11'25	11'25	18'5	18'5	0



SERIE 600

*Incremento por lacado mate y premium
*Matte lacquered and premium upcharge

| 234 |



***Marble shiny upcharge
Incremento por mármol brillo

| 68 |



Incremento por base laca brillo
Upcharge for bright lacquered finish bases.

| 501 |



Incremento por base de roble
Oak base upcharge

| 1,290 |

ME23301

Ø 31.50 / 31.50 x 31.50 H13.75

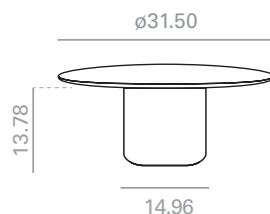

Top shape

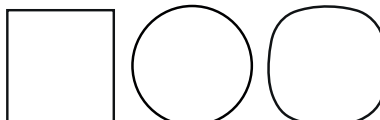

Square Round Ellipse

	Top & Base
	Cement Cemento
\$	
3,550	
lbs	0
1 box / bulto Ft	11'25

ME23302

Ø 35.50 / 35.50 x 35.50 H13.75

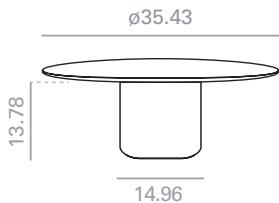

Top shape

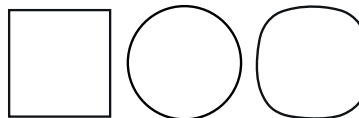

Square Round Ellipse

	Table top / Sobre				
	*Oak Roble	Lacquered Lacado	***M1 Marble Mármol M1	***M2 Marble Mármol M2	Compacto HPL
	\$	\$	\$	\$	\$
	2,523	2,061	4,144	5,332	1,964
lbs	0	0	0	0	0
1 box / bulto Ft	12'5	12'5	21'25	21'25	0

	Table top / Sobre				
	Compacto HPL Decorative	Compacto HPL Premium	Technical Stone 8	Technical Stone 8 Premium	Solid Surface
	\$	\$	\$	\$	\$
	2,140	2,400	3,326	3,533	2,444
lbs	0	0	0	0	0
1 box / bulto Ft	0	0	21'25	21'25	0



*Incremento por lacado mate y premium
*Matte lacquered and premium upcharge

246



***Marble shiny upcharge
Incremento por mármol brillo

68



Incremento por base laca brillo
Upcharge for bright lacquered finish bases.

501



Incremento por base de roble
Oak base upcharge

1,290

ME23303

Ø 35.50 / 35.50 x 35.50 H13.75

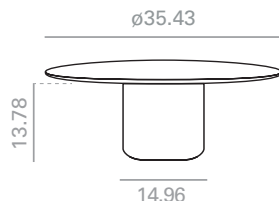

Top shape

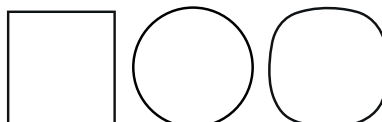

Square Round Ellipse

	Top & Base
	Cement Cemento
	\$
	3,731
lbs	0
1 box / bulto Ft	12'5

ME23304

Ø 39.50 / 39.50 x 39.50 H13.75

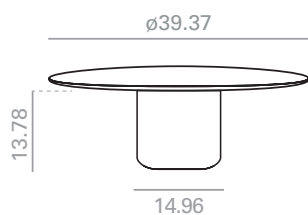

Top shape

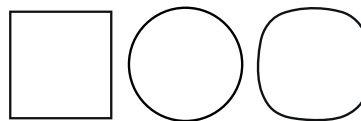

Square Round Ellipse

	Table top / Sobre				
	*Oak Roble	Lacquered Lacado	***M1 Marble Mármol M1	***M2 Marble Mármol M2	Compacto HPL
	\$	\$	\$	\$	\$
	2,692	2,178	5,526	6,997	2,052
lbs	0	0	0	0	0
1 box / bulto Ft	13'75	13'75	24	24	13'75

	Table top / Sobre			
	Compacto HPL Decorative	Compacto HPL Premium	Technical Stone 8	Technical Stone 8 Premium
	\$	\$	\$	\$
	2,296	2,728	3,711	3,946
lbs	0	0	0	0
1 box / bulto Ft	13'75	13'75	24	24



SERIE 600
*Incremento por lacado mate y premium
*Matte lacquered and premium upcharge

260



***Marble shiny upcharge
Incremento por mármol brillo

68



Incremento por base laca brillo
Upcharge for bright lacquered finish bases.

501



Incremento por base de roble
Oak base upcharge

1,290

ME23305

Ø 39.50 / 39.50 x 39.50 H13.75

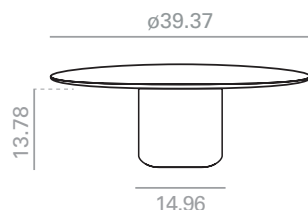

Top shape

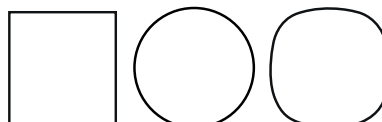

Square Round Ellipse

	Top & Base
	Cement Cemento
	\$
	4,074
lbs	0
1 box / bulto Ft	21'75

ME23306

Ø 43.25 / 43.25 x 43.25 H13.75

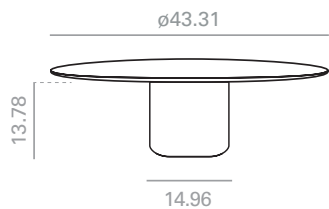

Top shape

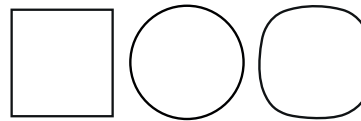

Square Round Ellipse

	Table top / Sobre				
	*Oak Roble	Lacquered Lacado	***M1 Marble Mármol M1	***M2 Marble Mármol M2	Compacto HPL
	\$	\$	\$	\$	\$
	2,734	2,263	6,027	8,040	2,345
lbs	0	0	0	0	0
1 box / bulto Ft	9	9	21	21	9

	Table top / Sobre	
	Compacto HPL Decorative	Compacto HPL Premium
	\$	\$
	2,637	2,890
lbs	0	0
1 box / bulto Ft	9	9



*Incremento por lacado mate y premium
*Matte lacquered and premium upcharge

274



***Marble shiny upcharge
Incremento por mármol brillo

68



Incremento por base laca brillo
Upcharge for bright lacquered finish bases.

501



Incremento por base de roble
Oak base upcharge

1,290

ME23307

Ø 43.25 / 43.25 x 43.25 H13.75

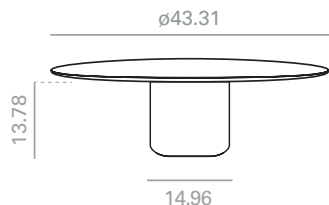

Top shape

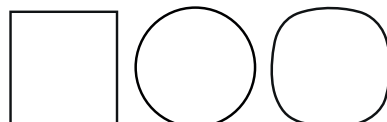

Square Round Ellipse

	Top & Base
	Cement Cemento
	\$
	4,208
lbs	0
1 box / bulto Ft	18'5

ME23308

Ø 43.25 / 43.25 x 43.25 H17.75

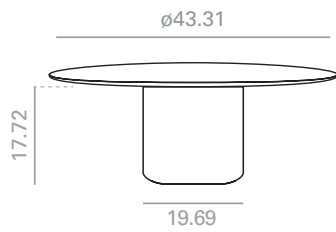

Top shape

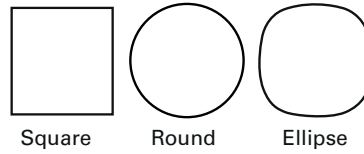

	Table top / Sobre				
	*Oak Roble	Lacquered Lacado	***M1 Marble Mármol M1	***M2 Marble Mármol M2	Compacto HPL
	\$	\$	\$	\$	\$
	2,963	2,470	6,412	8,522	2,556
lbs	0	0	0	0	0
1 box / bulto Ft	15'25	15'25	27	27	15'25

	Table top / Sobre	
	Compacto HPL Decorative	Compacto HPL Premium
	\$	\$
	2,864	3,128
lbs	0	0
1 box / bulto Ft	15'25	15'25



*Incremento por lacado mate y premium
*Matte lacquered and premium upcharge

274



***Marble shiny upcharge
Incremento por mármol brillo

68



Incremento por base laca brillo
Upcharge for bright lacquered finish bases.

501



Incremento por base de roble
Oak base upcharge

1,438

ME23309

Ø 43.25 / 43.25 x 43.25 H17.75

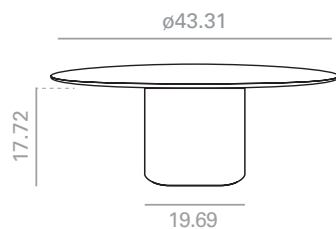

Top shape

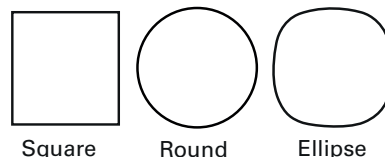

	Top & Base
	Cement Cemento
	\$
	4,413
lbs	0
1 box / bulto Ft	24'5

ME23310

Ø 47.25 / 47.25 x 47.25 H17.75

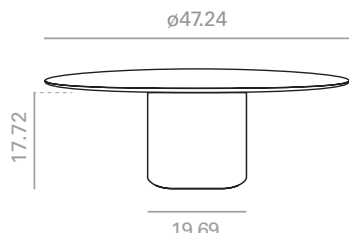

Top shape

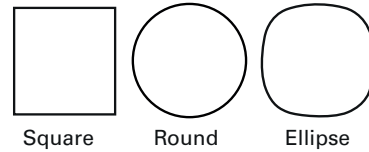

	Table top / Sobre				
	*Oak Roble	Lacquered Lacado	***M1 Marble Mármol M1	***M2 Marble Mármol M2	Compacto HPL
	\$	\$	\$	\$	\$
	3,410	2,921	8,264	10,787	2,895
lbs	0	0	0	0	0
1 box / bulto Ft	16'75	16'75	30'5	30'5	16'75

	Table top / Sobre	
	Compacto HPL Decorative	Compacto HPL Premium
	\$	\$
	3,262	3,561
lbs	0	0
1 box / bulto Ft	16'75	16'75



SERIE 600
*Incremento por lacado mate y premium
*Matte lacquered and premium upcharge

315



***Marble shiny upcharge
Incremento por mármol brillo

68



Incremento por base laca brillo
Upcharge for bright lacquered finish bases.

501



Incremento por base de roble
Oak base upcharge

1,438

ME23311

Ø 47.25 / 47.25 x 47.25 H17.75

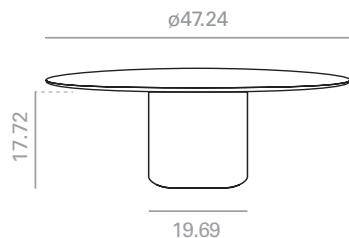

Top shape

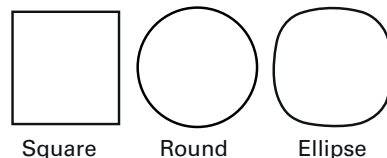

	Top & Base
	Cement Cemento
	\$
	4,663
lbs	0
1 box / bulto Ft	0

ME23312

Ø 51.25 / 51.25 x 51.25 H17.75

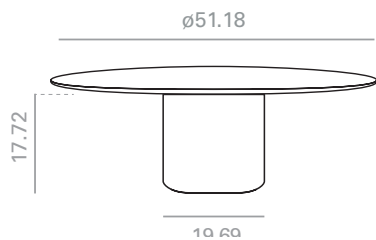

Top shape

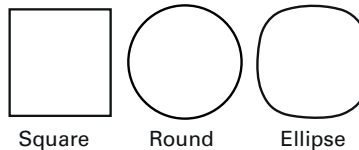

	Table top / Sobre				
	*Oak Roble	Lacquered Lacado	***M1 Marble Mármol M1	***M2 Marble Mármol M2	Compacto HPL
	\$	\$	\$	\$	\$
	3,530	3,025	9,291	11,883	3,000
lbs	0	0	0	0	0
1 box / bulto Ft	18'25	18'25	78'5	78'5	18'25

	Table top / Sobre	
	Compacto HPL Decorative	Compacto HPL Premium
	\$	\$
	3,370	3,682
lbs	0	0
1 box / bulto Ft	18'25	18'25



*Incremento por lacado mate y premium
*Matte lacquered and premium upcharge

334



***Marble shiny upcharge
Incremento por mármol brillo

68



Incremento por base laca brillo
Upcharge for bright lacquered finish bases.

501



Incremento por base de roble
Oak base upcharge

1,438

ME23313

Ø 51.25 / 51.25 x 51.25 H17.75

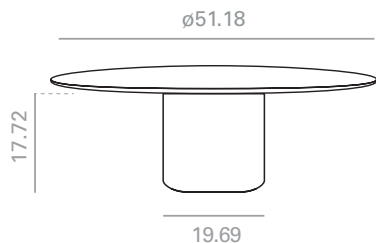

Top shape

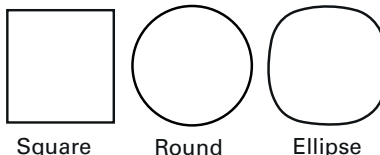

	Top & Base
	Cement Cemento
	\$
	4,567
lbs	0
1 box / bulto Ft	12'25

ME23314

Ø 55.25 / 55.25 x 55.25 H17.75

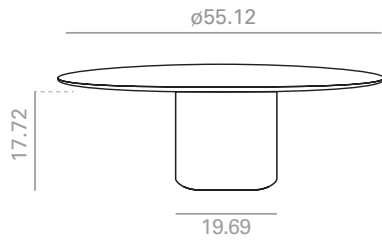

Top shape

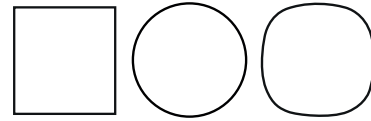

Square Round Ellipse

	Table top / Sobre				
	*Oak Roble	Lacquered Lacado	***M1 Marble Mármol M1	***M2 Marble Mármol M2	Compacto HPL
	\$	\$	\$	\$	\$
	3,651	3,130	9,670	12,338	3,102
lbs	0	0	0	0	0
1 box / bulto Ft	20	20	87'75	87'75	20

	Table top / Sobre	
	Compacto HPL Decorative	Compacto HPL Premium
	\$	\$
	3,486	3,801
lbs	0	0
1 box / bulto Ft	20	20



SERIE 600
*Incremento por lacado mate y premium
*Matte lacquered and premium upcharge

354



***Marble shiny upcharge
Incremento por mármol brillo

68



Incremento por base laca brillo
Upcharge for bright lacquered finish bases.

501



Incremento por base de roble
Oak base upcharge

1,438

ME23315

Ø 55.25 / 55.25 x 55.25 H17.75

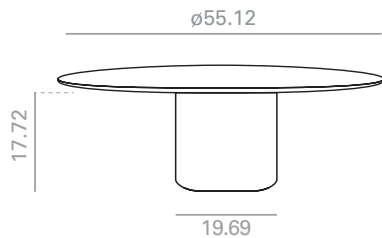

Top shape

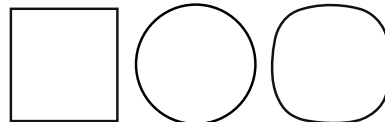

Square Round Ellipse

	Top & Base
	Cement Cemento
	\$
	4,892
lbs	0
1 box / bulto Ft	20

PS-UNDERTOP

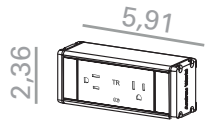

PS3300 247

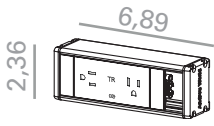

PS3301 342

Preinstalled (Optional) / Preinstalación (Opcional) 1522
IN0007

**UNDER-TOP POWER BOXES
CAJA DE CONEXIONES BAJO EL SOBRE**

Power box mounted under the table top. Available in black. There are two power system sizes available and data slots can be customized according to the below diagram.

Regleta de conexiones bajo la superficie del sobre. Se sirve en color negro. Se ofrecen formatos de caja de dos tamaños de caja diferentes y con opciones de conectividad configurable.

PS0754

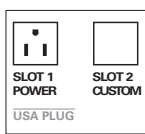

CHOOSE DATA PORT FOR DATA CUSTOM PORT SLOTS

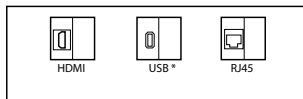

* Only data

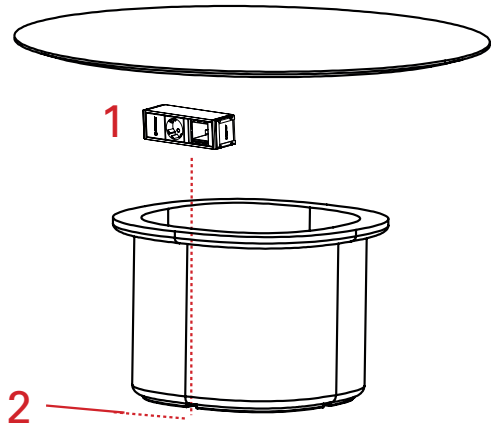

1 POWER BOXES DISTRIBUTION DISTRIBUCIÓN DE SISTEMAS

By standard, the arrangement of the system will be in the center of the long side of the table, in longitudinal direction and at 75 mm from the edge.

De serie, la disposición del sistema será en el centro del lado largo de la mesa, en sentido longitudinal y a 75 mm del canto.

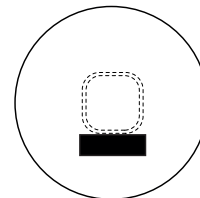

2 WIRING MANAGEMENT SALIDA DE CABLEADO

The cable passes through an aluminum wire manager, keeping it hidden from the users.

El cable pasa a través de un perfil de aluminio que lo mantiene oculto.

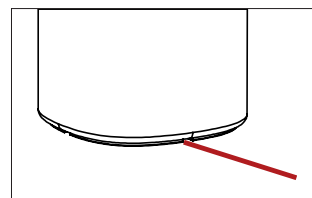

**OPTIONAL PREINSTALLED WIRING
PREINSTALACIÓN DEL CABLEADO**

IN0007

Preinstalled wiring consists in the addition of the necessary mechanisms to integrate power systems in the table, so that wiring is hidden until the way out in the door. Necessary grommet are included and 3m cable (from the power system).

La preinstalación consiste en el montaje de los mecanismos necesarios para integrar el sistema de electrificación en la mesa, de modo que el cableado quede oculto hasta su salida por la base. Se incluyen los pasacables necesarios y 3 metros de cable (midiendo desde el sistema de conexiones).

