

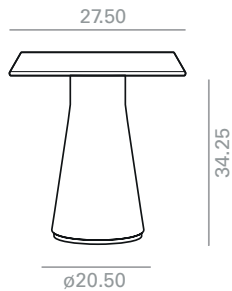

## ME05810

27.50 x 27.50 H34.50



Height adjustable glides upcharge  
Incremento por tacos reguladores

96



\*Incremento por lacado mate y premium  
\*Matte lacquered and premium upcharge

227

**Top Edge/ Perfil**

**Top 18**

**lbs**

**1 box / bulto Ft**

Table top / Sobre			
*Oak Roble	Lacquered Lacado	Laminate HPL Laminado HPL	Ultra-matte Ultramate
\$	\$	\$	\$
1,817	1,751	1,645	1,885
157	157	157	157
12'75	12'75	12'75	12'75



Square

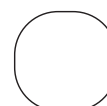

Ellipse

**Top Edge/ Perfil**

**Top 23**

**lbs**

**1 box / bulto Ft**

Table top / Sobre			
Maple Arce	Lacquered Lacado	Linoleum Linóleo	Ultra-matte Ultramate
\$	\$	\$	\$
1,716	1,747	2,213	2,022
157	157	157	157
12'75	12'75	12'75	12'75



Square

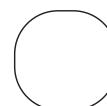

Ellipse

**Top Edge/ Perfil**

**Top SP 40**

**lbs**

**1 box / bulto Ft**

Table top / Sobre			
Maple Arce	Lacquered Lacado	Laminate HPL Laminado HPL	Ultra-matte Ultramate
\$	\$	\$	\$
1,980	1,881	1,837	2,175
157	157	157	157
12'75	12'75	12'75	12'75



Square

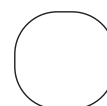

Ellipse

**Top Edge/ Perfil**

**Top 30 Square**

**lbs**

**1 box / bulto Ft**

Table top / Sobre	
Laminate HPL Laminado HPL	Ultra-matte Ultramate
\$	\$
1,667	1,874
157	157
12'75	12'75



Square

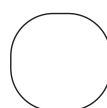

Ellipse

**Top Edge/ Perfil**

**Top Technical Stone**

**lbs**

**1 box / bulto Ft**



Table top / Sobre	
Technical Stone 12	Technical Stone 12 premium
\$	\$
2,776	2,978
157	157
15'25	15'25



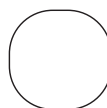



Square



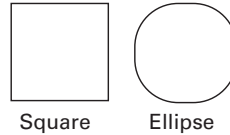



Ellipse

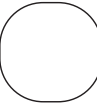

<p><b>Top Edge/ Perfil</b></p> <p><b>Top Compacto HPL</b></p>  <p><b>lbs</b></p> <p><b>1 box / bulto</b>  <b>Ft</b></p>	Table top / Sobre		
	Compacto HPL	Compacto HPL Decorative	Compacto HPL Premium
	\$	\$	\$
	1,656	1,821	1,982
	155	155	155
	15	15	15

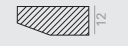

<p><b>Top Edge/ Perfil</b></p> <p><b>Top glass</b></p>  <p><b>lbs</b></p> <p><b>1 box / bulto</b>  <b>Ft</b></p>	Table top / Sobre		 <p>Square</p>  <p>Ellipse</p>
	Low Iron Glass Cristal óptico		
	\$		
	2,732		
	170		
	18'75		

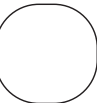
<p><b>Top Edge/ Perfil</b></p> <p><b>Top Square</b></p>  <p><b>lbs</b></p> <p><b>1 box / bulto</b>  <b>Ft</b></p>	Table top / Sobre		 <p>Square</p>
	Laminate Laminado		
	\$		
	1,689		
	157		
	12'75		

<p><b>Top Edge/ Perfil</b></p> <p><b>Top Solid Surface</b></p>  <p><b>lbs</b></p> <p><b>1 box / bulto</b>  <b>Ft</b></p>	Table top / Sobre		 <p>Square</p>  <p>Ellipse</p>
	Solid Surface		
	\$		
	2,358		
	157		
	15'25		

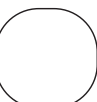
<p><b>Top Edge/ Perfil</b></p> <p><b>Top Cement</b></p>  <p><b>lbs</b></p> <p><b>1 box / bulto</b>  <b>Ft</b></p>	Top & Base		 <p>Square</p>  <p>Ellipse</p>
	Cement Cemento		
	\$		
	3,675		
	157		
	15'25		

## ME05811

31.50 x 31.50 H34.50

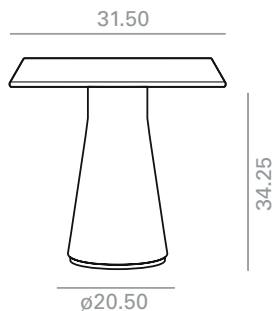

Height adjustable glides upcharge  
Incremento por tacos reguladores

96



\*Incremento por lacado mate y premium  
\*Matte lacquered and premium upcharge

241

**Top Edge/  
Perfil**

**Top 18**

**lbs**

**1 box / bulto** **Ft**

Table top / Sobre			
*Oak Roble	Lacquered Lacado	Laminate HPL Laminado HPL	Ultra-matte Ultramate
\$	\$	\$	\$
2,052	1,879	1,936	2,393
168	168	168	168
13'5	13'5	13'5	13'5



Square

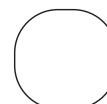

Ellipse

**Top Edge/  
Perfil**

**Top 23**

**lbs**

**1 box / bulto** **Ft**

Table top / Sobre			
Maple Arce	Lacquered Lacado	Linoleum Linóleo	Ultra-matte Ultramate
\$	\$	\$	\$
1,872	1,876	2,398	2,158
168	168	168	168
13'5	13'5	13'5	13'5



Square

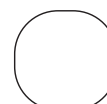

Ellipse

**Top Edge/  
Perfil**

**Top SP 40**

**lbs**

**1 box / bulto** **Ft**

Table top / Sobre			
Maple Arce	Lacquered Lacado	Laminate HPL Laminado HPL	Ultra-matte Ultramate
\$	\$	\$	\$
2,191	2,068	2,026	2,382
168	168	168	168
13'5	13'5	13'5	13'5



Square

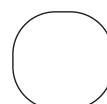

Ellipse

**Top Edge/  
Perfil**

**Top 30 Square**

**lbs**

**1 box / bulto** **Ft**

Table top / Sobre	
Laminate HPL Laminado HPL	Ultra-matte Ultramate
\$	\$
1,942	2,299
168	168
13'5	13'5



Square

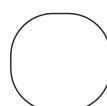

Ellipse

**Top Edge/  
Perfil**

**Top Technical Stone**

**lbs**

**1 box / bulto** **Ft**



Table top / Sobre	
Technical Stone 12	Technical Stone 12 premium
\$	\$
3,097	3,359
161	161
16'25	16'25



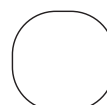



Square



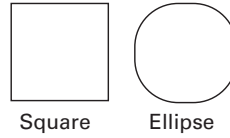



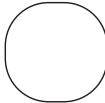

Ellipse



<p><b>Top Edge/ Perfil</b></p> <p><b>Top Compacto HPL</b></p>  <p><b>lbs</b></p> <p><b>1 box / bulto</b>  <b>Ft</b></p>	Table top / Sobre		
	Compacto HPL	Compacto HPL Decorative	Compacto HPL Premium
	\$	\$	\$
	1,747	1,969	2,061
	159	159	159
	15'5	15'5	15'5

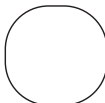

<p><b>Top Edge/ Perfil</b></p> <p><b>Top glass</b></p>  <p><b>lbs</b></p> <p><b>1 box / bulto</b>  <b>Ft</b></p>	Table top / Sobre		 <p>Square</p>  <p>Ellipse</p>
	Low Iron Glass Cristal óptico		
	\$		
	2,941		
	170		
	20'5		

<p><b>Top Edge/ Perfil</b></p> <p><b>Top Square</b></p>  <p><b>lbs</b></p> <p><b>1 box / bulto</b>  <b>Ft</b></p>	Table top / Sobre		 <p>Square</p>
	Laminate Laminado		
	\$		
	1,720		
	168		
	13'5		

<p><b>Top Edge/ Perfil</b></p> <p><b>Top Solid Surface</b></p>  <p><b>lbs</b></p> <p><b>1 box / bulto</b>  <b>Ft</b></p>	Table top / Sobre		 <p>Square</p>  <p>Ellipse</p>
	Solid Surface		
	\$		
	2,725		
	166		
	16'25		

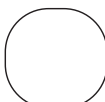
<p><b>Top Edge/ Perfil</b></p> <p><b>Top Cement</b></p>  <p><b>lbs</b></p> <p><b>1 box / bulto</b>  <b>Ft</b></p>	Top & Base		 <p>Square</p>  <p>Ellipse</p>
	Cement Cemento		
	\$		
	3,818		
	166		
	16'25		

## ME05812

35.50 x 35.50 H34.50

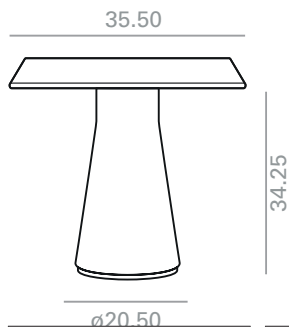

Height adjustable glides upcharge  
Incremento por tacos reguladores

96



\*Incremento por lacado mate y premium  
\*Matte lacquered and premium upcharge

260

<b>Top Edge/ Perfil</b>
<b>Top 18</b>

<b>lbs</b>
<b>1 box / bulto Ft</b>

Table top / Sobre			
*Oak Roble	Lacquered Lacado	Laminate HPL Laminado HPL	Ultra-matte Ultramate
\$	\$	\$	\$
2,362	2,037	2,134	2,459
172	172	172	172
14'25	14'25	14'25	14'25



Square

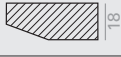
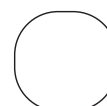

Ellipse

<b>Top Edge/ Perfil</b>
<b>Top 23</b>

<b>lbs</b>
<b>1 box / bulto Ft</b>

Table top / Sobre			
Maple Arce	Lacquered Lacado	Linoleum Linóleo	Ultra-matte Ultramate
\$	\$	\$	\$
2,055	2,044	2,585	2,525
172	172	172	172
14'25	14'25	14'25	14'25



Square

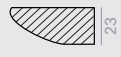
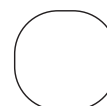

Ellipse

<b>Top Edge/ Perfil</b>
<b>Top SP 40</b>

<b>lbs</b>
<b>1 box / bulto Ft</b>

Table top / Sobre			
Maple Arce	Lacquered Lacado	Laminate HPL Laminado HPL	Ultra-matte Ultramate
\$	\$	\$	\$
2,378	2,230	2,193	2,543
172	172	172	172
14'25	14'25	14'25	14'25



Square

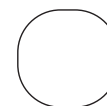

Ellipse

<b>Top Edge/ Perfil</b>
<b>Top 30 Square</b>

<b>lbs</b>
<b>1 box / bulto Ft</b>

Table top / Sobre	
Laminate HPL Laminado HPL	Ultra-matte Ultramate
\$	\$
2,156	2,618
172	172
14'25	14'25



Square

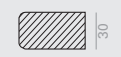
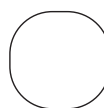

Ellipse

<b>Top Edge/ Perfil</b>
<b>Top Technical Stone</b>

<b>lbs</b>
<b>1 box / bulto Ft</b>



Table top / Sobre	
Technical Stone 12	Technical Stone 12 premium
\$	\$
3,599	3,937
166	166
17	17



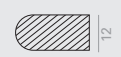
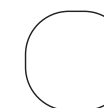



Square



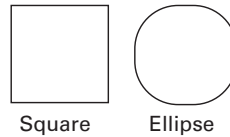



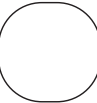

Ellipse



<p><b>Top Edge/ Perfil</b></p> <p><b>Top Compacto HPL</b></p>  <p><b>lbs</b></p> <p><b>1 box / bulto</b>  <b>Ft</b></p>	Table top / Sobre		
	Compacto HPL	Compacto HPL Decorative	Compacto HPL Premium
	\$	\$	\$
	1,872	2,151	2,274
	164	164	164
	16'5	16'5	16'5

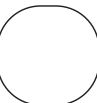

<p><b>Top Edge/ Perfil</b></p> <p><b>Top glass</b></p>  <p><b>lbs</b></p> <p><b>1 box / bulto</b>  <b>Ft</b></p>	Table top / Sobre		  <p>Square      Ellipse</p>
	Low Iron Glass Cristal óptico		
	\$		
	3,049		
	186		
	22'5		

<p><b>Top Edge/ Perfil</b></p> <p><b>Top Square</b></p>  <p><b>lbs</b></p> <p><b>1 box / bulto</b>  <b>Ft</b></p>	Table top / Sobre		 <p>Square</p>
	Laminate Laminado		
	\$		
	1,769		
	172		
	14'25		

<p><b>Top Edge/ Perfil</b></p> <p><b>Top Solid Surface</b></p>  <p><b>lbs</b></p> <p><b>1 box / bulto</b>  <b>Ft</b></p>	Table top / Sobre		  <p>Square      Ellipse</p>
	Solid Surface		
	\$		
	2,752		
	175		
	17		

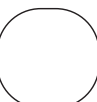
<p><b>Top Edge/ Perfil</b></p> <p><b>Top Cement</b></p>  <p><b>lbs</b></p> <p><b>1 box / bulto</b>  <b>Ft</b></p>	Top & Base		  <p>Square      Ellipse</p>
	Cement Cemento		
	\$		
	4,051		
	175		
	17		

## ME05813

39.50 x 39.50 / Ø39.50 H34.50

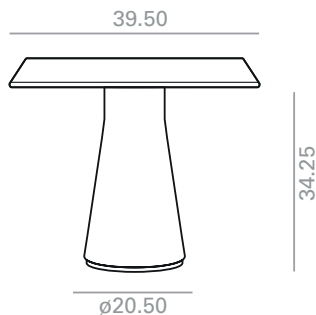

Height adjustable glides upcharge  
Incremento por tacos reguladores

| 96 |



\*Incremento por lacado mate y premium  
\*Matte lacquered and premium upcharge

| 274 |

**Top Edge/ Perfil**

**Top 18**

**lbs**

**1 box / bulto** **Ft**

Table top / Sobre			
*Oak Roble	Lacquered Lacado	Laminate HPL Laminado HPL	Ultra-matte Ultramate
\$	\$	\$	\$
2,501	2,129	2,167	2,494
181	181	181	181
15	15	15	15



Square

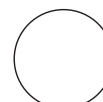

Round

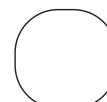

Ellipse

**Top Edge/ Perfil**

**Top 23**

**lbs**

**1 box / bulto** **Ft**

Table top / Sobre			
Maple Arce	Lacquered Lacado	Linoleum Linóleo	Ultra-matte Ultramate
\$	\$	\$	\$
2,224	2,077	2,897	2,897
181	181	181	181
15	15	15	15



Square

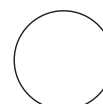

Round

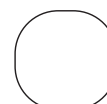

Ellipse

**Top Edge/ Perfil**

**Top SP 40**

**lbs**

**1 box / bulto** **Ft**

Table top / Sobre			
Maple Arce	Lacquered Lacado	Laminate HPL Laminado HPL	Ultra-matte Ultramate
\$	\$	\$	\$
2,813	2,640	2,549	2,963
181	181	181	181
15	15	15	15



Square

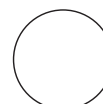

Round

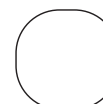

Ellipse

**Top Edge/ Perfil**

**Top 30 Square**

**lbs**

**1 box / bulto** **Ft**

Table top / Sobre	
Laminate HPL Laminado HPL	Ultra-matte Ultramate
\$	\$
2,206	2,798
181	181
15	15



Square

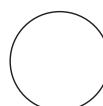

Round

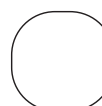

Ellipse

**Top Edge/ Perfil**

**Top Technical Stone**

**lbs**

**1 box / bulto** **Ft**

Table top / Sobre	
Technical Stone 12	Technical Stone 12 premium
\$	\$
3,986	4,402
170	170
18'25	18'25



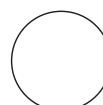

Square



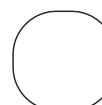

Round





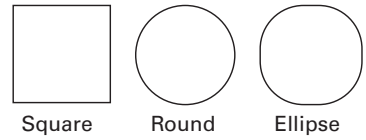

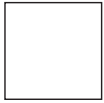
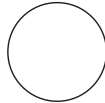
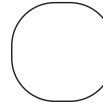

Ellipse

<p><b>Top Edge/ Perfil</b></p> <p><b>Top Compacto HPL</b></p>  <p><b>lbs</b></p> <p><b>1 box / bulto</b>  <b>Ft</b></p>	Table top / Sobre		
	Compacto HPL	Compacto HPL Decorative	Compacto HPL Premium
	\$	\$	\$
	2,026	2,371	2,527
	170	170	170
	17'25	17'25	17'25



<p><b>Top Edge/ Perfil</b></p> <p><b>Top glass</b></p>  <p><b>lbs</b></p> <p><b>1 box / bulto</b>  <b>Ft</b></p>	Table top / Sobre			
	Low Iron Glass Cristal óptico			
	\$	Square	Round	Ellipse
	3,315			
	197			
	24'5			

<p><b>Top Edge/ Perfil</b></p> <p><b>Top Square</b></p>  <p><b>lbs</b></p> <p><b>1 box / bulto</b>  <b>Ft</b></p>	Table top / Sobre			
	Laminat Laminado			
	\$	Square		
	1,964			
	181			
	15			

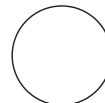
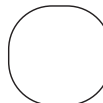
<p><b>Top Edge/ Perfil</b></p> <p><b>Top Cement</b></p>  <p><b>lbs</b></p> <p><b>1 box / bulto</b>  <b>Ft</b></p>	Top & Base			
	Cement Cemento			
	\$	Square	Round	Ellipse
	4,238			
	181			
	15			

## ME05814

43.25 x 43.25 / Ø43.25 H34.50

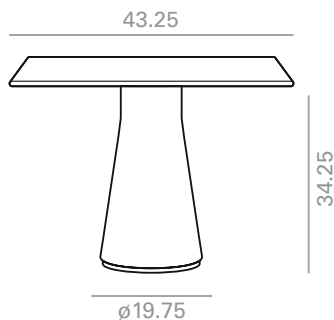

Height adjustable glides upcharge  
Incremento por tacos reguladores

| 96 |



\*Incremento por lacado mate y premium  
\*Matte lacquered and premium upcharge

| 297 |

<b>Top Edge/ Perfil</b>
<b>Top 18</b>

<b>lbs</b>
<b>1 box / bulto Ft</b>

Table top / Sobre			
*Oak Roble	Lacquered Lacado	Laminate HPL Laminado HPL	Ultra-matte Ultramate
\$	\$	\$	\$
2,598	2,270	2,259	2,824
179	179	179	179
16	16	16	16



Square

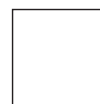
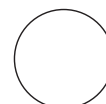

Round

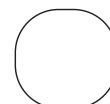

Ellipse

<b>Top Edge/ Perfil</b>
<b>Top 23</b>

<b>lbs</b>
<b>1 box / bulto Ft</b>

Table top / Sobre			
Maple Arce	Lacquered Lacado	Linoleum Linóleo	Ultra-matte Ultramate
\$	\$	\$	\$
2,413	2,290	3,302	3,302
179	179	179	179
16	16	16	16



Square

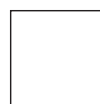
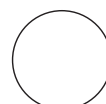

Round

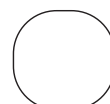

Ellipse

<b>Top Edge/ Perfil</b>
<b>Top SP 40</b>

<b>lbs</b>
<b>1 box / bulto Ft</b>

Table top / Sobre			
Maple Arce	Lacquered Lacado	Laminate HPL Laminado HPL	Ultra-matte Ultramate
\$	\$	\$	\$
2,965	2,800	2,697	3,172
179	179	179	179
16	16	16	16



Square

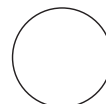

Round

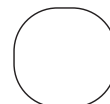

Ellipse

<b>Top Edge/ Perfil</b>
<b>Top 30 Square</b>

<b>lbs</b>
<b>1 box / bulto Ft</b>

Table top / Sobre	
Laminate HPL Laminado HPL	Ultra-matte Ultramate
\$	\$
2,272	2,921
179	179
16	16



Square

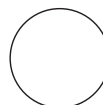

Round

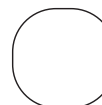

Ellipse

<b>Top Edge/ Perfil</b>
<b>Top glass</b>

<b>lbs</b>
<b>1 box / bulto Ft</b>

Table top / Sobre	
Low Iron Glass Cristal óptico	
\$	
3,643	
172	
27	



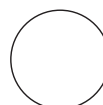

Square



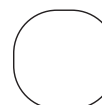



Round



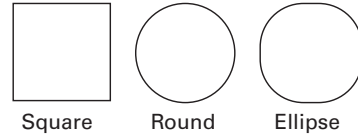

Ellipse

<p><b>Top Edge/ Perfil</b></p> <p><b>Top Compacto HPL</b></p>  <p><b>lbs</b></p> <p><b>1 box / bulto</b>  <b>Ft</b></p>	Table top / Sobre		
	Compacto HPL	Compacto HPL Decorative	Compacto HPL Premium
	\$	\$	\$
	2,336	2,763	2,952
	168	168	168
	18'25	18'25	18'25

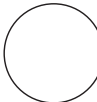
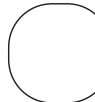

<p><b>Top Edge/ Perfil</b></p> <p><b>Top Square</b></p>  <p><b>lbs</b></p> <p><b>1 box / bulto</b>  <b>Ft</b></p>	Table top / Sobre	 <p>Square</p>
	Laminate Laminado	
	\$	
	2,077	
	179	
	16	

<p><b>Top Edge/ Perfil</b></p> <p><b>Top Cement</b></p>  <p><b>lbs</b></p> <p><b>1 box / bulto</b>  <b>Ft</b></p>	Top & Base	 <span>Square</span>  <span>Round</span>  <span>Ellipse</span>
	Cement Cemento	
	\$	
	4,383	
	179	
	16	

## ME05900

39.50 x 39.50 / Ø39.50 H43.00

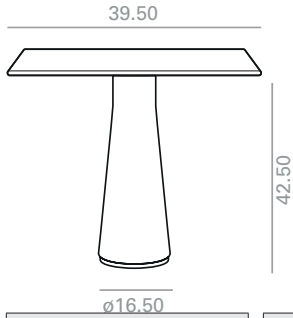

Height adjustable glides upcharge  
Incremento por tacos reguladores

96



\*Incremento por lacado mate y premium  
\*Matte lacquered and premium upcharge

274

**Top Edge/ Perfil**

**Top 18**

**lbs**

**1 box / bulto** **Ft**

Table top / Sobre			
*Oak Roble	Lacquered Lacado	Laminate HPL Laminado HPL	Ultra-matte Ultramate
\$	\$	\$	\$
2,490	2,134	2,171	2,483
294	294	294	294
45'75	45'75	45'75	45'75



Square

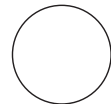

Round

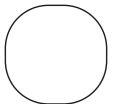

Ellipse

**Top Edge/ Perfil**

**Top 23**

**lbs**

**1 box / bulto** **Ft**

Table top / Sobre			
Maple Arce	Lacquered Lacado	Linoleum Linóleo	Ultra-matte Ultramate
\$	\$	\$	\$
2,226	2,083	2,868	2,868
294	294	294	294
45'75	45'75	45'75	45'75



Square

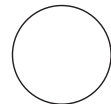

Round

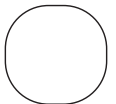

Ellipse

**Top Edge/ Perfil**

**Top SP 40**

**lbs**

**1 box / bulto** **Ft**

Table top / Sobre			
Maple Arce	Lacquered Lacado	Laminate HPL Laminado HPL	Ultra-matte Ultramate
\$	\$	\$	\$
2,791	2,624	2,538	2,932
294	294	294	294
45'75	45'75	45'75	45'75



Square

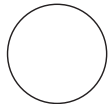

Round

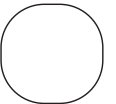

Ellipse

**Top Edge/ Perfil**

**Top 30 Square**

**lbs**

**1 box / bulto** **Ft**

Table top / Sobre	
Laminate HPL Laminado HPL	Ultra-matte Ultramate
\$	\$
2,206	2,774
294	294
45'75	45'75



Square

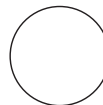

Round

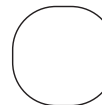

Ellipse

**Top Edge/ Perfil**

**Top Technical Stone**

**lbs**

**1 box / bulto** **Ft**

Table top / Sobre	
Technical Stone 12	Technical Stone 12 premium
\$	\$
4,056	5,017
198	198
13'75	13'75



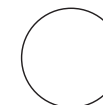

Square



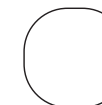



Round



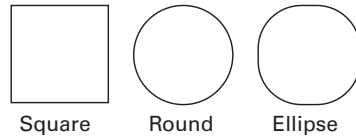



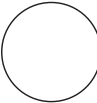
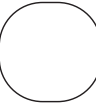

Ellipse

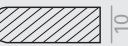

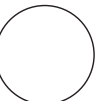
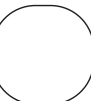
<p><b>Top Edge/ Perfil</b></p> <p><b>Top Compacto HPL</b></p>  <p><b>lbs</b></p> <p><b>1 box / bulto</b>  <b>Ft</b></p>	Table top / Sobre		
	Compacto HPL	Compacto HPL Decorative	Compacto HPL Premium
	\$	\$	\$
	2,035	2,409	2,571
	294	294	294
	13'75	13'75	13'75



<p><b>Top Edge/ Perfil</b></p> <p><b>Top Terrazzo</b></p>  <p><b>lbs</b></p> <p><b>1 box / bulto</b>  <b>Ft</b></p>	Table top / Sobre			
	Terrazzo			
	\$	Square	Round	Ellipse
	4,646			
	294			
	21'25			

<p><b>Top Edge/ Perfil</b></p> <p><b>Top glass</b></p>  <p><b>lbs</b></p> <p><b>1 box / bulto</b>  <b>Ft</b></p>	Table top / Sobre			
	Low Iron Glass Cristal óptico			
	\$	Square	Round	Ellipse
	3,273			
	294			
	21'25			

<p><b>Top Edge/ Perfil</b></p> <p><b>Top Square</b></p>  <p><b>lbs</b></p> <p><b>1 box / bulto</b>  <b>Ft</b></p>	Table top / Sobre			
	Laminado Laminado			
	\$	Square		
	1,975			
	294			
	45'75			

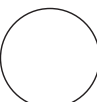
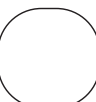
<p><b>Top Edge/ Perfil</b></p> <p><b>Top Cement</b></p>  <p><b>lbs</b></p> <p><b>1 box / bulto</b>  <b>Ft</b></p>	Top & Base			
	Cement Cemento			
	\$	Square	Round	Ellipse
	3,924			
	294			
	45'75			

## ME05901

43.25 x 43.25 / Ø43.25 H43.50

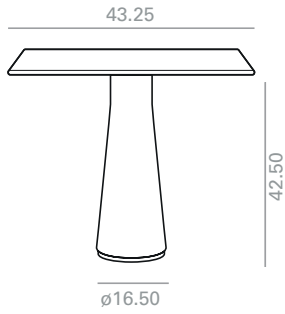



Height adjustable glides  
upcharge  
Incremento por tacos  
reguladores

96



\*Incremento por lacado  
mate y premium  
\*Matte lacquered and  
premium upcharge

297

Top Edge/ Perfil	Table top / Sobre			
	*Oak Roble	Lacquered Lacado	Laminate HPL Laminado HPL	Ultra-matte Ultramate
Top 18 	\$	\$	\$	\$
	2,688	2,356	2,347	2,915
 lbs	294	294	294	294
1 box / bulto  Ft	45'75	45'75	45'75	45'75



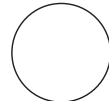

Square

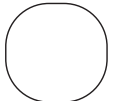

Round



Ellipse

Top Edge/ Perfil	Table top / Sobre			
	Maple Arce	Lacquered Lacado	Linoleum Linóleo	Ultra-matte Ultramate
Top 23 	\$	\$	\$	\$
	2,505	2,382	3,396	3,396
 lbs	294	294	294	294
1 box / bulto  Ft	45'75	45'75	45'75	45'75



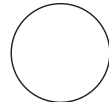

Square

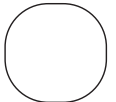

Round



Ellipse

Top Edge/ Perfil	Table top / Sobre			
	Maple Arce	Lacquered Lacado	Laminate HPL Laminado HPL	Ultra-matte Ultramate
Top SP 40 	\$	\$	\$	\$
	3,055	2,893	2,789	3,267
 lbs	294	294	294	294
1 box / bulto  Ft	45'75	45'75	45'75	45'75



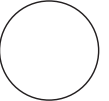

Square



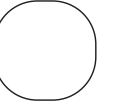



Round



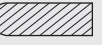

Ellipse

Top Edge/ Perfil	Table top / Sobre		Square	Round	Ellipse
	Laminate HPL Laminado HPL	Ultra-matte Ultramate			
Top 30 Square 	\$	\$			
	2,365	3,011			
 lbs	294	294			
1 box / bulto  Ft	45'75	45'75			

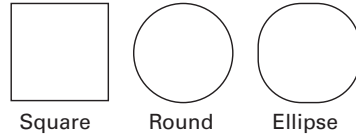

Top Edge/ Perfil	Table top / Sobre		Square	Round	Ellipse
	Low Iron Glass Cristal óptico				
Top glass 	\$				
	3,737				
 lbs	294				
1 box / bulto  Ft	23'5				

<p><b>Top Edge/ Perfil</b></p> <p><b>Top Compacto HPL</b></p>  <p><b>lbs</b></p> <p><b>1 box / bulto</b>  <b>Ft</b></p>	Table top / Sobre		
	Compacto HPL	Compacto HPL Decorative	Compacto HPL Premium
	\$	\$	\$
	2,428	2,901	3,110
	294	294	294
	14'75	14'75	14'75

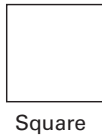

<p><b>Top Edge/ Perfil</b></p> <p><b>Top Square</b></p>  <p><b>lbs</b></p> <p><b>1 box / bulto</b>  <b>Ft</b></p>	Table top / Sobre
	Laminate Laminado
	\$
	2,164
	294
45'75	

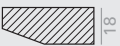

<p><b>Top Edge/ Perfil</b></p> <p><b>Top Cement</b></p>  <p><b>lbs</b></p> <p><b>1 box / bulto</b>  <b>Ft</b></p>	Top & Base
	Cement Cemento
	\$
	4,072
	294
	45'75

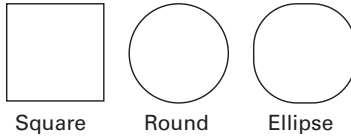

ME05902

Ø47.25 H43.00

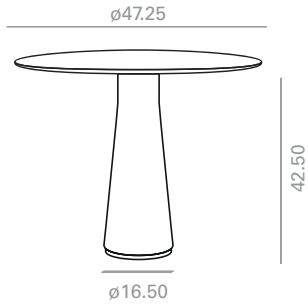



Height adjustable glides upcharge  
Incremento por tacos reguladores

96





\*Incremento por lacado mate y premium  
\*Matte lacquered and premium upcharge

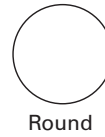

325

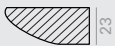
Top Edge/ Perfil	Table top / Sobre			
	*Oak Roble	Lacquered Lacado	Laminate HPL Laminado HPL	Ultra-matte Ultramate
Top 18 	\$	\$	\$	\$
	2,662	2,376	2,290	2,829
 lbs	294	294	294	294
1 box / bulto  Ft	45'75	45'75	45'75	45'75



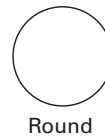

Top Edge/ Perfil	Table top / Sobre			
	Maple Arce	Lacquered Lacado	Linoleum Linóleo	Ultra-matte Ultramate
Top 23 	\$	\$	\$	\$
	2,565	2,406	3,440	3,440
 lbs	294	294	294	294
1 box / bulto  Ft	45'75	45'75	45'75	45'75





Top Edge/ Perfil	Table top / Sobre			
	Maple Arce	Lacquered Lacado	Laminate HPL Laminado HPL	Ultra-matte Ultramate
Top SP 40 	\$	\$	\$	\$
	3,227	2,983	3,077	3,621
 lbs	294	294	294	294
1 box / bulto  Ft	45'75	45'75	45'75	45'75

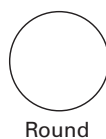

Top Edge/ Perfil	Table top / Sobre	
	Laminate HPL Laminado HPL	Ultra-matte Ultramate
Top 30 Square 	\$	\$
	2,340	2,948
 lbs	294	294
1 box / bulto  Ft	45'75	45'75



Top Edge/ Perfil	Table top / Sobre	
	Low Iron Glass Cristal óptico	
Top glass 	\$	
	4,371	
 lbs	294	
1 box / bulto  Ft	64	

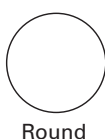

<p><b>Top Edge/ Perfil</b></p> <p><b>Top Compacto HPL</b></p>  <p><b>lbs</b></p> <p><b>1 box / bulto Ft</b></p>	Table top / Sobre		
	Compacto HPL	Compacto HPL Decorative	Compacto HPL Premium
	\$	\$	\$
	2,349	2,642	2,776
	294	294	294
	16	16	16

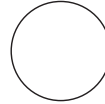

Round

<p><b>Top Edge/ Perfil</b></p> <p><b>Top Cement</b></p>  <p><b>lbs</b></p> <p><b>1 box / bulto Ft</b></p>	Top & Base
	Cement Cemento
	\$
	4,789
	294
	64

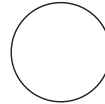

Round

## PS-INTREGATED

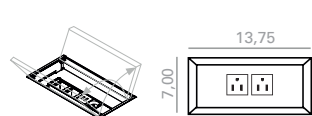

**PS3200** 1,163

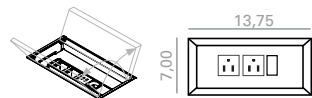

**PS3201** 1,258

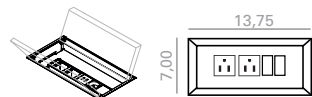

**PS3202** 1,361

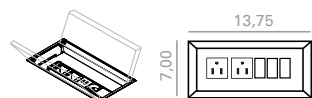

**PS3203** 1,470



**PS3204** 1,400

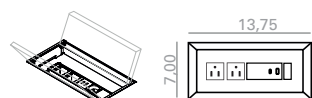

**PS3205** 1,494

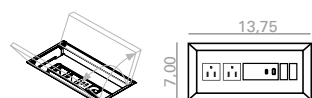

**PS3206** 1,599



**PS3207** 1,692



**PS3208** 1,275



**PS3209** 1,371



**PS3210** 1,473



**PS3211** 1,586



**PS3212** 1,511

## PS-UNDERTOP

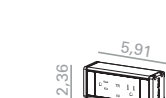

**PS3300** 247

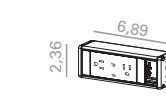

**PS3301** 342

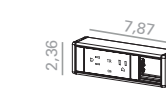

**PS3302** 447

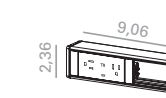

**PS3303** 553

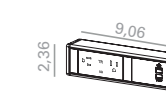

**PS3304** 486

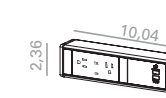

**PS3305** 580

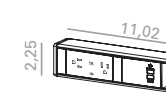

**PS3306** 682

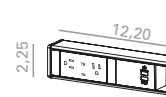

**PS3307** 383

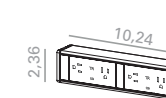

**PS3308** 359

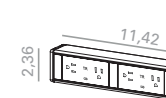

**PS3309** 454

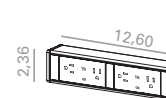

**PS3310** 559

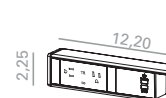



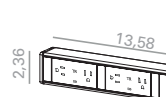



**PS3311** 671

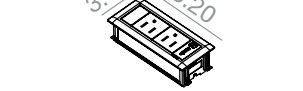

**PS3312** 596

## PS-IN SURFACE

	<b>PS0739</b>	<u>1,296</u>
	<b>PS0740</b>	<u>1,407</u>
	<b>PS0466</b>	<u>1,090</u>
	<b>PS0467</b>	<u>1,408</u>
	<b>PS0764</b>	<u>502</u>
	<b>PS0713</b>	<u>519</u>

## PS-QI



<b>PS0714</b>	<u>530</u>
---------------	------------

## SOCKET TOWER TORRE DE CONEXIONES

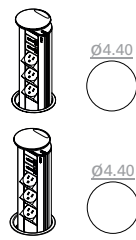

<b>PS0795</b>	<u>969</u>
<b>PS0796</b>	<u>1,002</u>

## PS-INTEGRATED WITHOUT POWER SYSTEM

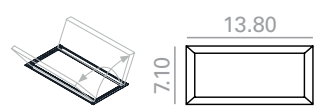

<b>PS0232</b>	<u>916</u>
---------------	------------

## PS-GROMMET 60 (ALU)



<u>230</u>
------------

## PS-GROMMET 60 (TP)



<u>75</u>
-----------

## PS-GROMMET 80 (ALU)



<u>312</u>
------------

## PS-GROMMET 80 (TP)



<u>88</u>
-----------

## PS-SNAKE



<u>331</u>
------------

## PS-UNDERTOP

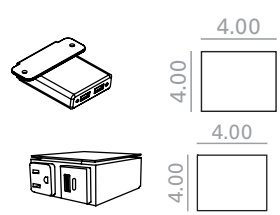

<b>PS0715</b>	<u>398</u>
---------------	------------

<b>PS0723</b>	<u>342</u>
---------------	------------

## PS-QI



<b>PS0714</b>	<u>530</u>
---------------	------------

<b>PS0716</b>	<u>469</u>
---------------	------------

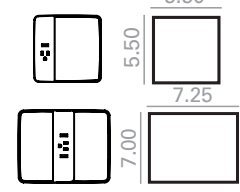

<b>PS0717</b>	<u>750</u>
---------------	------------

## CUT-OUT

<b>CO1</b>	Group 1 (oak, walnut, ash, lacquered, compacto, laminate, linoleum, ultramate, solid surface)..	<u>187</u>
<b>CO2</b>	Grupo 2 (mármol, cristal, technical stone).	<u>497</u>

Unit price. It must be accompanied by a plan with measurement and position.  
 Precio unitario. Requiere ir acompañado de plano con medida y posición.

## Preinstalled (Optional) / Preinstalación (Opcional) IN0006

First installation / Primera instalación	<u>604</u>
Second and more installations / Segunda y más instalaciones	<u>212</u>

**INTEGRATED POWER BOXES  
CAJAS DE CONEXIONES INTEGRADAS**

The integrated system has a cover of the same nish as the top, being perfectly integrated and only a small frame of black finish is always visible. The opening of the system is to both sides.

El sistema integrado lleva una tapeta del mismo acabado que el top, quedando perfectamente integrado y solo se ve un pequeño marco de acabado siempre negro. La apertura del sistema es hacia ambos lados.

**PS3200** 1,163

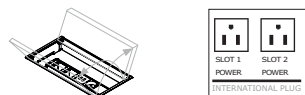

**PS3201** 1,258



**PS3202** 1,361



**PS3203** 1,470

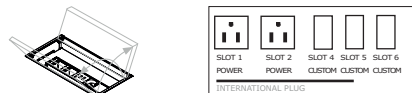

**PS3204** 1,400



**PS3205** 1,494

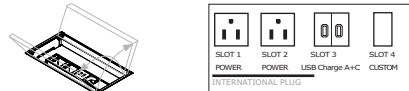

**PS3206** 1,599

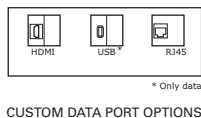
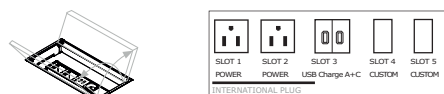

\* Only data  
CUSTOM DATA PORT OPTIONS

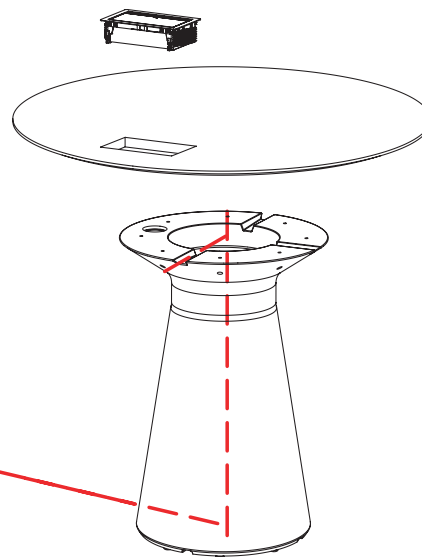

**1 POWER BOXES DISTRIBUTION DISTRIBUCIÓN DE SISTEMAS**

In tables with only one Reverse base power box can't be centered with the base. In tables with more than one base, by default power box is placed in the center of the table and in lengthwise direction.

En mesas con una sola base el sistema eléctrico iría instalado descentrado respecto a la base. En mesas con más de una base, por defecto la posición del sistema irá en el centro de la mesa y en sentido longitudinal.

**2 WIRING MANAGEMENT GESTIÓN DEL CABLEADO**

The cable passes through an aluminum wire manager, keeping it hidden from the users.

El cable pasa a través de un perfil de aluminio que lo mantiene oculto.

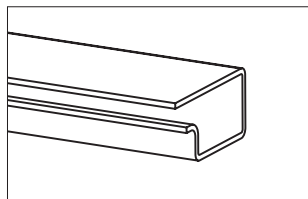

**3 CABLE WAY OUT SALIDA DE CABLEADO**

The cable way out can be performed directly from the leg itself through a hole in the lower part.

La salida del cable se realiza directamente desde la pata por un hueco realizado en la parte inferior.

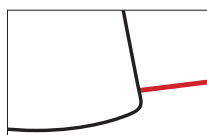

**INTEGRATED POWER BOXES  
CAJAS DE CONEXIONES INTEGRADAS**

The integrated system has a cover of the same nish as the top, being perfectly integrated and only a small frame of black finish is always visible. The opening of the system is to both sides.

El sistema integrado lleva una tapeta del mismo acabado que el top, quedando perfectamente integrado y solo se ve un pequeño marco de acabado siempre negro. La apertura del sistema es hacia ambos lados.

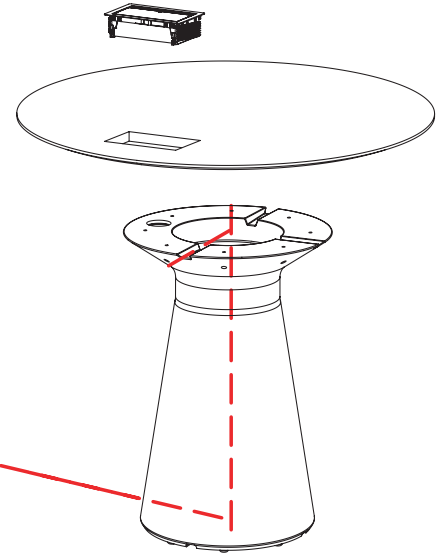

**PS3207** 1,692

**PS3208** 1,275

**PS3209** 1,371

**PS3210** 1,473

**PS3211** 1,586

**PS3212** 1,511



\* Only data

CUSTOM DATA PORT OPTIONS

**1 POWER BOXES DISTRIBUTION DISTRIBUCIÓN DE SISTEMAS**

In tables with only one Reverse base power box can't be centered with the base. In tables with more than one base, by default power box is placed in the center of the table and in lengthwise direction.

En mesas con una sola base el sistema eléctrico iría instalado descentrado respecto a la base. En mesas con más de una base, por defecto la posición del sistema irá en el centro de la mesa y en sentido longitudinal.

**2 WIRING MANAGEMENT GESTIÓN DEL CABLEADO**

The cable passes through an aluminum wire manager, keeping it hidden from the users.

El cable pasa a través de un perfil de aluminio que lo mantiene oculto.

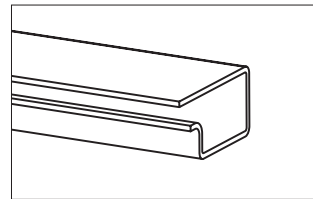

**3 CABLE WAY OUT SALIDA DE CABLEADO**

The cable way out can be performed directly from the leg itself through a hole in the lower part.

La salida del cable se realiza directamente desde la pata por un hueco realizado en la parte inferior.

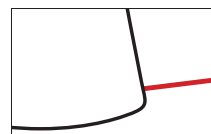

**OPTIONAL PREINSTALLED WIRING  
PREINSTALACIÓN DEL CABLEADO**

**IN0006**

Preinstalled wiring consists in the addition of the necessary mechanisms to integrate power systems in the table, so that wiring is hidden until the way out in the door. Necessary grommet are included and 3m cable (from the power system).

La preinstalación consiste en el montaje de los mecanismos necesarios para integrar el sistema de electrificación en la mesa, de modo que el cableado quede oculto hasta su salida por la base. Se incluyen los pasacables necesarios y 3 metros de cable (midiéndolo desde el sistema de conexiones).

**UNDER-TOP POWER BOXES  
CAJA DE CONEXIONES BAJO EL SOBRE**

Power box mounted under the table top. Available in black. There are two power system sizes available and data slots can be customized according to the below diagram.

Regleta de conexiones bajo la superficie del sobre. Se sirve en color negro. Se ofrecen formatos de caja de dos tamaños de caja diferentes y con opciones de conectividad configurable.

<b>PS3300</b>	247	
<b>PS3301</b>	342	
<b>PS3302</b>	447	
<b>PS3303</b>	553	
<b>PS3304</b>	486	
<b>PS3305</b>	580	
<b>PS3306</b>	682	

\* Only data  
CHOOSE DATA PORT FOR DATA CUSTOM PORT SLOTS

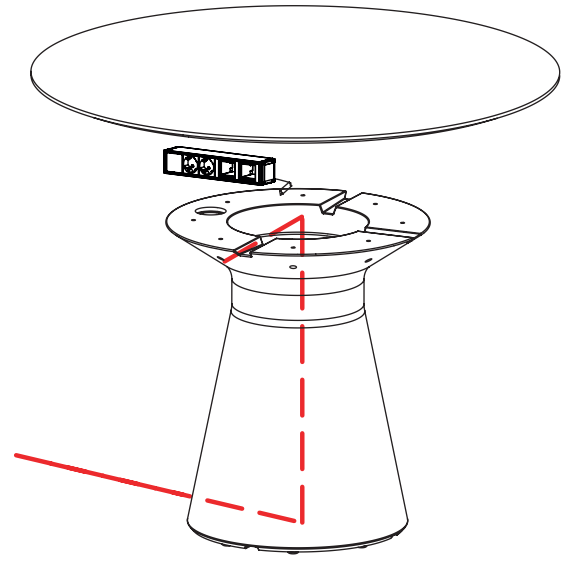

**1 POWER BOXES DISTRIBUTION DISTRIBUCIÓN DE SISTEMAS**

By standard, the arrangement of the system will be in the center of the long side of the table, in longitudinal direction and at 75 mm from the edge.

De serie, la disposición del sistema será en el centro del lado largo de la mesa, en sentido longitudinal y a 75 mm del canto.

**2 WIRING MANAGEMENT GESTIÓN DEL CABLEADO**

The cable passes through an aluminum wire manager, keeping it hidden from the users.

El cable pasa a través de un perfil de aluminio que lo mantiene oculto.

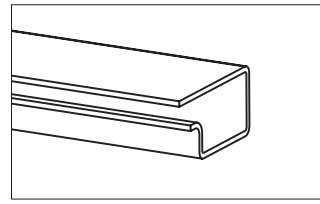

**3 CABLE WAY OUT SALIDA DE CABLEADO**

The cable way out can be performed directly from the leg itself through a hole in the lower part.

La salida del cable se realiza directamente desde la pata por un hueco realizado en la parte inferior.

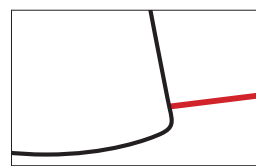

**UNDER-TOP POWER BOXES  
CAJA DE CONEXIONES BAJO EL SOBRE**

Power box mounted under the table top. Available in black. There are two power system sizes available and data slots can be customized according to the below diagram.

Regleta de conexiones bajo la superficie del sobre. Se sirve en color negro. Se ofrecen formatos de caja de dos tamaños de caja diferentes y con opciones de conectividad configurable.

**PS3307** 383

**PS3308** 359

**PS3309** 454

**PS3310** 559

**PS3311** 671

**PS3312** 596

**OPTIONAL PREINSTALLED WIRING  
PREINSTALACIÓN DEL CABLEADO**

**IN0006**

Preinstalled wiring consists in the addition of the necessary mechanisms to integrate power systems in the table, so that wiring is hidden until the way out in the door. Necessary grommet are included and 3m cable (from the power system).

La preinstalación consiste en el montaje de los mecanismos necesarios para integrar el sistema de electrificación en la mesa, de modo que el cableado quede oculto hasta su salida por la base. Se incluyen los pasacables necesarios y 3 metros de cable (midiéndolo desde el sistema de conexiones).

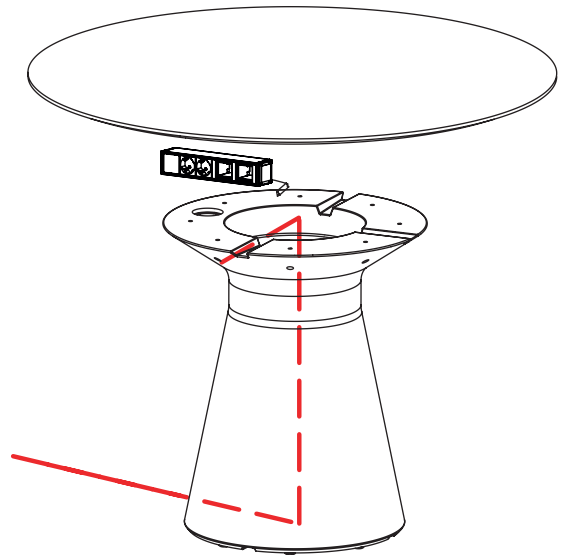

**1 POWER BOXES DISTRIBUTION DISTRIBUCIÓN DE SISTEMAS**

By standard, the arrangement of the system will be in the center of the long side of the table, in longitudinal direction and at 75 mm from the edge.

De serie, la disposición del sistema será en el centro del lado largo de la mesa, en sentido longitudinal y a 75 mm del canto.

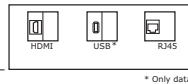

\* Only data

CHOOSE DATA PORT FOR DATA CUSTOM PORT SLOTS

**2 WIRING MANAGEMENT GESTIÓN DEL CABLEADO**

The cable passes through an aluminum wire manager, keeping it hidden from the users.

El cable pasa a través de un perfil de aluminio que lo mantiene oculto.

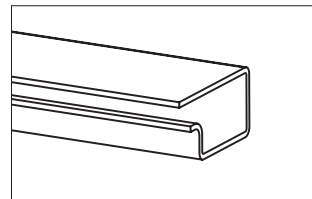

**3 CABLE WAY OUT SALIDA DE CABLEADO**

The cable way out can be performed directly from the leg itself through a hole in the lower part.

La salida del cable se realiza directamente desde la pata por un hueco realizado en la parte inferior.

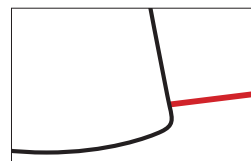

**QI CHARGING POWER BOXES  
CAJAS DE CONEXIONES QI**

The inductive charging station allows us to charge any device that has Qi technology built in. With a wide charging surface, just leave the device centered over the corresponding area. Available in black finish.

La estación de carga inductiva nos permite cargar cualquier dispositivo que tenga la tecnología Qi incorporada. Con una superficie de carga amplia, solo se debe dejar el dispositivo centrado sobre el area correspondiente. Dsponible en acabado negro.

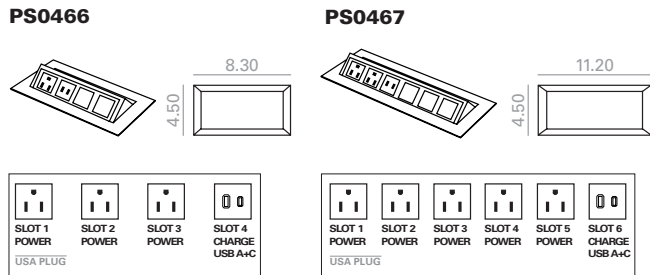
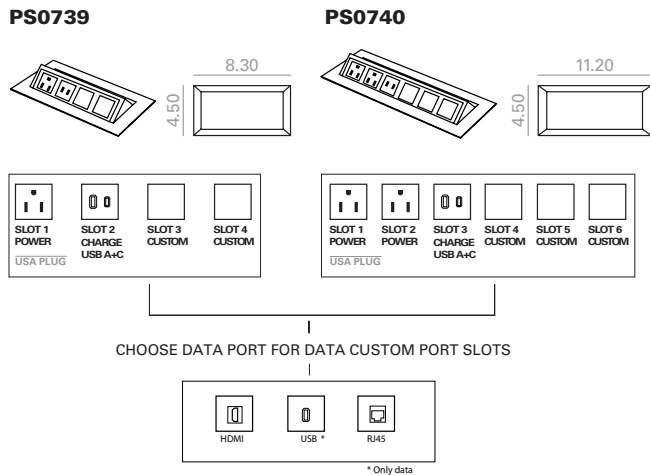

**OPTIONAL PREINSTALLED WIRING  
PREINSTALACIÓN DEL CABLEADO**

**IN0006**

Preinstalled wiring consists in the addition of the necessary mechanisms to integrate power systems in the table, so that wiring is hidden until the way out in the door. Necessary grommet are included and 3m cable (from the power system).

La preinstalación consiste en el montaje de los mecanismos necesarios para integrar el sistema de electrificación en la mesa, de modo que el cableado quede oculto hasta su salida por la base. Se incluyen los pasacables necesarios y 3 metros de cable (midiéndolo desde el sistema de conexiones).

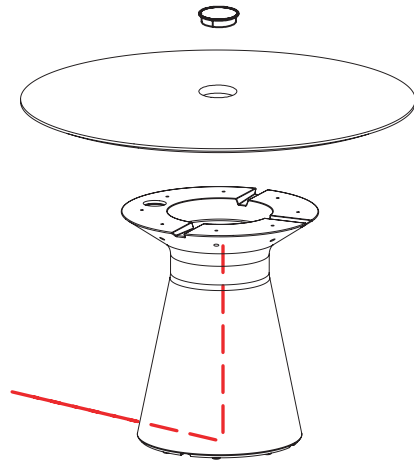

**1 POWER BOXES DISTRIBUTION DISTRIBUCIÓN DE SISTEMAS**

In tables with only one Reverse base power box can't be centered with the base. In tables with more than one base, by default power box is placed in the center of the table and in lengthwise direction.

En mesas con una sola base el sistema eléctrico iría instalado descentrado respecto a la base. En mesas con más de una base, por defecto la posición del sistema irá en el centro de la mesa y en sentido longitudinal.

**2 WIRING MANAGEMENT GESTIÓN DEL CABLEADO**

The cable passes through an aluminum wire manager, keeping it hidden from the users.

El cable pasa a través de un perfil de aluminio que lo mantiene oculto.

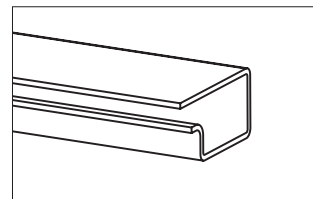

**3 CABLE WAY OUT SALIDA DE CABLEADO**

The cable way out can be performed directly from the leg through a hole in the lower part.

La salida del cable se realiza directamente desde la pata por un hueco realizado en la parte inferior.

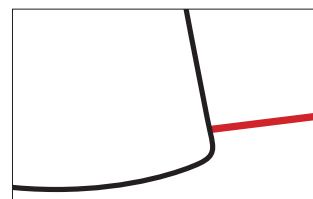

**IN-SURFACE POWER BOXES  
CAJAS DE CONEXIONES DENTRO DEL SOBRE**

Aluminum power box mounted in the table top with a folding protective lid. The lid rotates 360° to give full access to the system. It is served in anodized silver, black or white.

Caja de conexiones de aluminio con tapa instalada en la superficie del sobre. La tapa se gira 360° para dar acceso total al sistema. Se sirve en color anodizado plata, negro o blanco.

**PS0713**

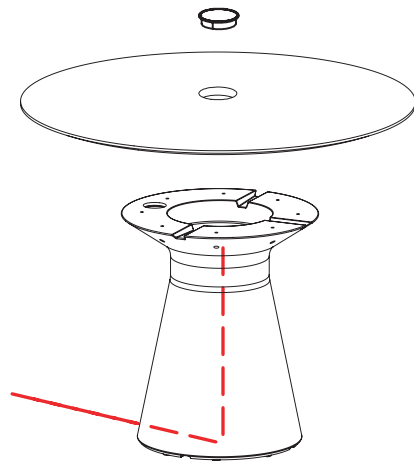
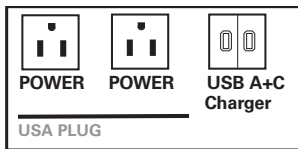
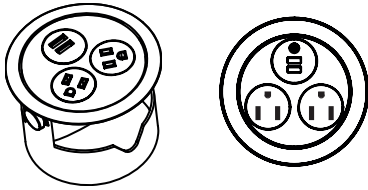

**1 POWER BOXES DISTRIBUTION DISTRIBUCIÓN DE SISTEMAS**

In tables with only one Reverse base power box can't be centered with the base. In tables with more than one base, by default power box is placed in the center of the table and in lengthwise direction.

En mesas con una sola base el sistema eléctrico iría instalado descentrado respecto a la base. En mesas con más de una base, por defecto la posición del sistema irá en el centro de la mesa y en sentido longitudinal.

**2 WIRING MANAGEMENT GESTIÓN DEL CABLEADO**

The cable passes through an aluminum wire manager, keeping it hidden from the users.

El cable pasa a través de un perfil de aluminio que lo mantiene oculto.

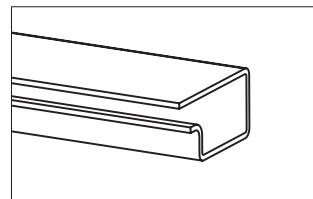

**3 CABLE WAY OUT SALIDA DE CABLEADO**

The cable way out can be performed directly from the leg itself through a hole in the lower part.

La salida del cable se realiza directamente desde la pata por un hueco realizado en la parte inferior.

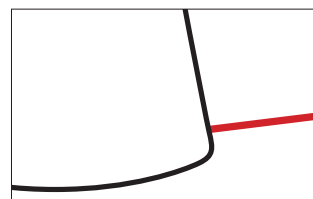

**OPTIONAL PREINSTALLED WIRING  
PREINSTALACIÓN DEL CABLEADO**

**IN0006**

Preinstalled wiring consists in the addition of the necessary mechanisms to integrate power systems in the table, so that wiring is hidden until the way out in the door. Necessary grommet are included and 3m cable (from the power system).

La preinstalación consiste en el montaje de los mecanismos necesarios para integrar el sistema de electrificación en la mesa, de modo que el cableado quede oculto hasta su salida por la base. Se incluyen los pasacables necesarios y 3 metros de cable (midiéndolo desde el sistema de conexiones).

**IN-SURFACE POWER BOXES  
CAJAS DE CONEXIONES DENTRO DEL SOBRE**

Compact and individual charging system with 5v and 2A of power can charge any brand of mobile phones, the ports will be A + C. Available in two finishes: black or white.

Sistema de carga compacto e individual con 5v y 2A de potencia puede cargar teléfonos móviles de cualquier marca, los puertos serán A + C. Disponible en dos acabados: negro o blanco

**PS0804**

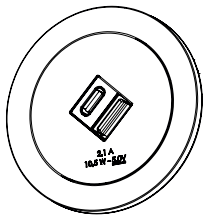

USB charger A+C

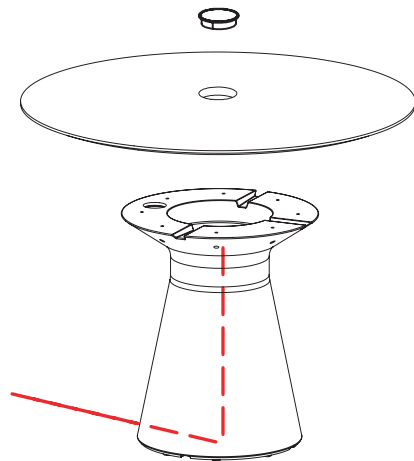

**1 POWER BOXES DISTRIBUTION DISTRIBUCIÓN DE SISTEMAS**

In tables with only one Reverse base power box can't be centered with the base. In tables with more than one base, by default power box is placed in the center of the table and in lengthwise direction.

En mesas con una sola base el sistema eléctrico iría instalado descentrado respecto a la base. En mesas con más de una base, por defecto la posición del sistema irá en el centro de la mesa y en sentido longitudinal.

**2 WIRING MANAGEMENT GESTIÓN DEL CABLEADO**

The cable passes through an aluminum wire manager, keeping it hidden from the users.

El cable pasa a través de un perfil de aluminio que lo mantiene oculto.

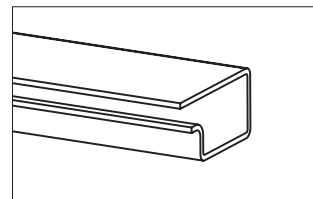

**3 CABLE WAY OUT SALIDA DE CABLEADO**

The cable way out can be performed directly from the leg itself through a hole in the lower part.

La salida del cable se realiza directamente desde la pata por un hueco realizado en la parte inferior.

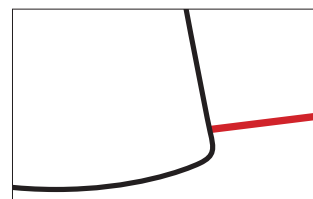

**OPTIONAL PREINSTALLED WIRING  
PREINSTALACIÓN DEL CABLEADO**

**IN0006**

Preinstalled wiring consists in the addition of the necessary mechanisms to integrate power systems in the table, so that wiring is hidden until the way out in the door. Necessary grommet are included and 3m cable (from the power system).

La preinstalación consiste en el montaje de los mecanismos necesarios para integrar el sistema de electrificación en la mesa, de modo que el cableado quede oculto hasta su salida por la base. Se incluyen los pasacables necesarios y 3 metros de cable (midiéndolo desde el sistema de conexiones).

**QI CHARGING POWER BOXES  
CAJAS DE CONEXIONES QI**

The inductive charging station allows us to charge any device that has Qi technology built in. With a wide charging surface, just leave the device centered over the corresponding area. Available in black finish.

La estación de carga inductiva nos permite cargar cualquier dispositivo que tenga la tecnología Qi incorporada. Con una superficie de carga amplia, solo se debe dejar el dispositivo centrado sobre el area correspondiente. Dsponible en acabado negro.

**PS0714**

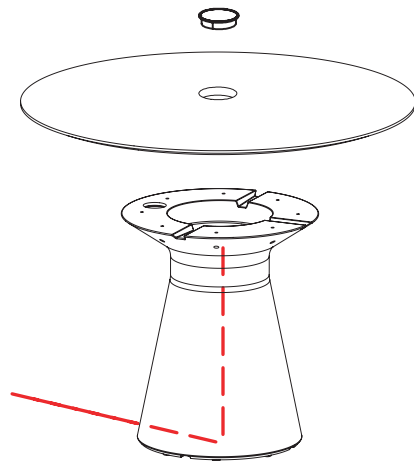
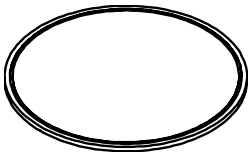

**1 POWER BOXES DISTRIBUTION DISTRIBUCIÓN DE SISTEMAS**

In tables with only one Reverse base power box can't be centered with the base. In tables with more than one base, by default power box is placed in the center of the table and in lenghtwise direction.

En mesas con una sola base el sistema eléctrico iría instalado descentrado respecto a la base. En mesas con más de una base, por defecto la posición del sistema irá en el centro de la mesa y en sentido longitudinal.

**2 WIRING MANAGEMENT GESTIÓN DEL CABLEADO**

The cable passes through an aluminum wire manager, keeping it hidden from the users.

El cable pasa a través de un perfil de aluminio que lo mantiene oculto.

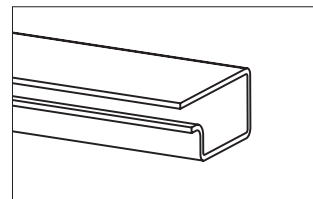

**3 CABLE WAY OUT SALIDA DE CABLEADO**

The cable way out can be performed directly from the leg itself through a hole in the lower part.

La salida del cable se realiza directamente desde la pata por un hueco realizado en la parte inferior.

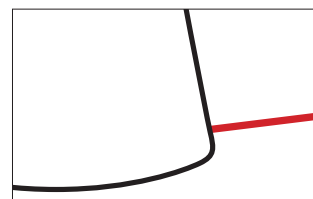

**OPTIONAL PREINSTALLED WIRING  
PREINSTALACIÓN DEL CABLEADO**

**IN0006**

Preinstalled wiring consists in the addition of the necessary mechanisms to integrate power systems in the table, so that wiring is hidden until the way out in the door. Necessary grommet are included and 3m cable (from the power system).

La preinstalación consiste en el montaje de los mecanismos necesarios para integrar el sistema de electrificación en la mesa, de modo que el cableado quede oculto hasta su salida por la base. Se incluyen los pasacables necesarios y 3 metros de cable (midiéndolo desde el sistema de conexiones).

**IN-SURFACE SOCKET POWERS  
TORRES DE CONEXIONES DENTRO DEL SOBRE**

Socket tower installed on the surface of the top. The hidden system is manually lifted when pressed. Valid for all Reverse bases. Available in silver, white or black.

Torre de conexiones instalada en la superficie del sobre. El sistema eléctrico oculto se alza manualmente al pulsarlo. Valido para todas las bases Reverse. Disponible en color plata, blanco o negro

**PS0795**

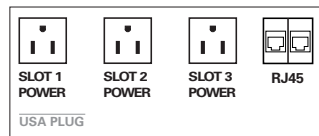
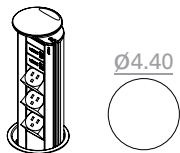

**PS0796**

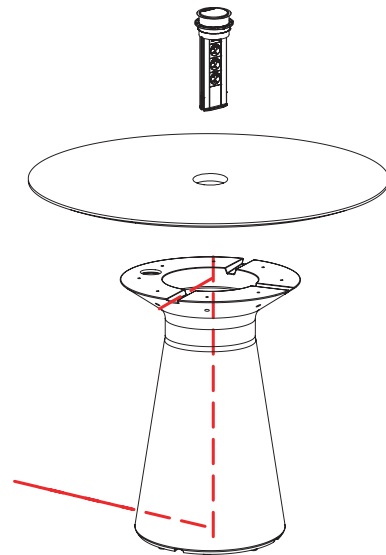
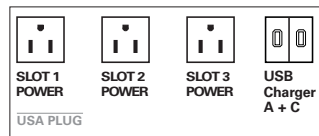
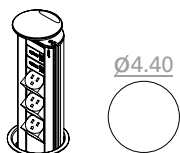

**1 POWER BOXES DISTRIBUTION DISTRIBUCIÓN DE SISTEMAS**

In tables with only one Reverse base power box can't be centered with the base. In tables with more than one base, by default power box is placed in the center of the table and in lengthwise direction.

De serie, la disposición del sistema será en el centro de la mesa, con 2 sistemas la posición sera centrado en el eje longitudinal a una distancia de 320 mm del centro de la mesa.

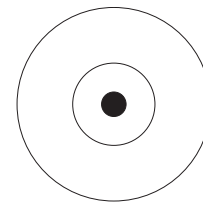

**2 WIRING MANAGEMENT GESTIÓN DEL CABLEADO**

The cable passes through an aluminum wire manager, keeping it hidden from the users.

El cable pasa a través de un perfil de aluminio que lo mantiene oculto.

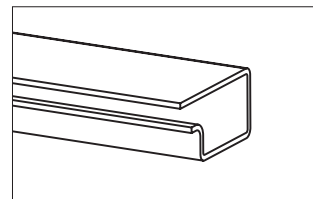

**3 CABLE WAY OUT SALIDA DE CABLEADO**

The cable way out can be performed directly from the leg itself through a hole in the lower part.

La salida del cable se realiza directamente desde la pata por un hueco realizado en la parte inferior.

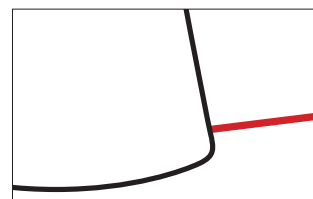

**OPTIONAL PREINSTALLED WIRING  
PREINSTALACIÓN DEL CABLEADO**

**IN0006**

Preinstalled wiring consists in the addition of the necessary mechanisms to integrate power systems in the table, so that wiring is hidden until the way out in the door. Necessary grommet are included and 3m cable (from the power system).

La preinstalación consiste en el montaje de los mecanismos necesarios para integrar el sistema de electrificación en la mesa, de modo que el cableado quede oculto hasta su salida por la base. Se incluyen los pasacables necesarios y 3 metros de cable (midiéndolo desde el sistema de conexiones).

**IN-SURFACE POWER BOXES  
CAJAS DE CONEXIONES DENTRO DEL SOBRE**

Aluminum power box mounted in the table top with a folding protective lid. It is served in anodized silver, white or black. There are two power system sizes available and data slots can be customized according to the below diagram.

Caja de conexiones de aluminio con tapa abatible instalada en la superficie del sobre. Se sirve en color anodizado plata, blanco o negro. Se ofrecen dos tamaños de caja de conexiones diferentes y con opciones de conectividad configurable según el diagrama inferior.

**PS0764**

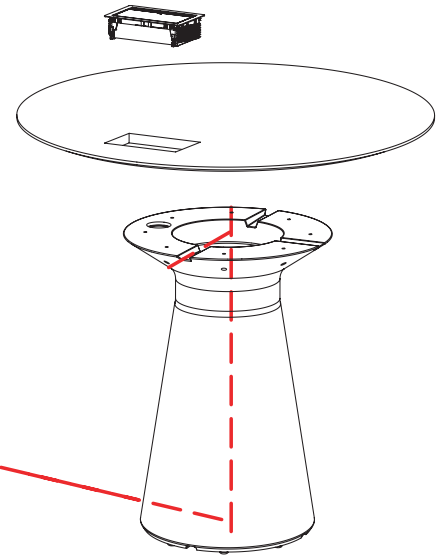
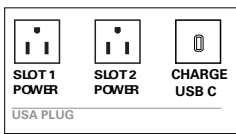
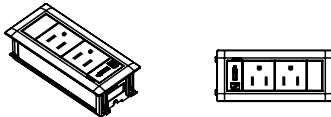

**1 POWER BOXES DISTRIBUTION DISTRIBUCIÓN DE SISTEMAS**

In tables with only one Reverse base power box can't be centered with the base. In tables with more than one base, by default power box is placed in the center of the table and in lengthwise direction.

En mesas con una sola base el sistema eléctrico iría instalado descentrado respecto a la base. En mesas con más de una base, por defecto la posición del sistema irá en el centro de la mesa y en sentido longitudinal.

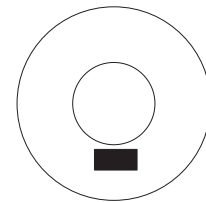

**2 WIRING MANAGEMENT GESTIÓN DEL CABLEADO**

The cable passes through an aluminum wire manager, keeping it hidden from the users.

El cable pasa a través de un perfil de aluminio que lo mantiene oculto.

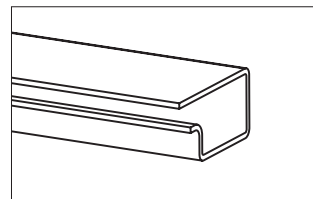

**3 CABLE WAY OUT SALIDA DE CABLEADO**

The cable way out can be performed directly from the leg itself through a hole in the lower part.

La salida del cable se realiza directamente desde la pata por un hueco realizado en la parte inferior.

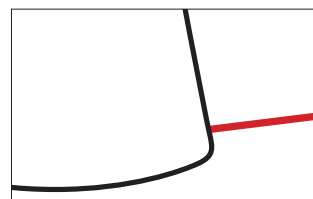

**OPTIONAL PREINSTALLED WIRING  
PREINSTALACIÓN DEL CABLEADO**

**IN0006**

Preinstalled wiring consists in the addition of the necessary mechanisms to integrate power systems in the table, so that wiring is hidden until the way out in the door. Necessary grommet are included and 3m cable (from the power system).

La preinstalación consiste en el montaje de los mecanismos necesarios para integrar el sistema de electrificación en la mesa, de modo que el cableado quede oculto hasta su salida por la base. Se incluyen los pasacables necesarios y 3 metros de cable (midiendo desde el sistema de conexiones).

**IN-SURFACE SOCKET POWERS  
TORRES DE CONEXIONES DENTRO DEL SOBRE**

Socket tower installed on the surface of the top. The hidden system is manually lifted when pressed. Valid for all Reverse bases. Available in silver, white or black.

Torre de conexiones instalada en la superficie del sobre. El sistema eléctrico oculto se alza manualmente al pulsarlo. Valido para todas las bases Reverse. Disponible en color plata, blanco o negro

**PS0795**

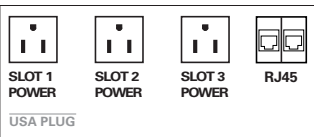
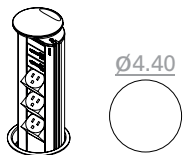

**PS0796**

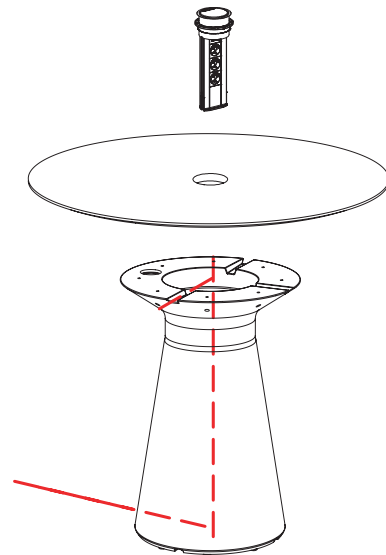
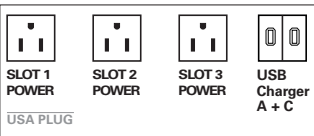
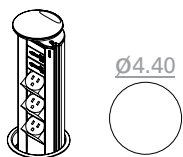

**1 POWER BOXES DISTRIBUTION DISTRIBUCIÓN DE SISTEMAS**

In tables with only one Reverse base power box can't be centered with the base. In tables with more than one base, by default power box is placed in the center of the table and in lengthwise direction.

De serie, la disposición del sistema será en el centro de la mesa, con 2 sistemas la posición sera centrado en el eje longitudinal a una distancia de 320 mm del centro de la mesa.

**2 WIRING MANAGEMENT GESTIÓN DEL CABLEADO**

The cable passes through an aluminum wire manager, keeping it hidden from the users.

El cable pasa a través de un perfil de aluminio que lo mantiene oculto.

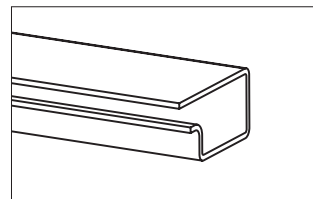

**3 CABLE WAY OUT SALIDA DE CABLEADO**

The cable way out can be performed directly from the leg itself through a hole in the lower part.

La salida del cable se realiza directamente desde la pata por un hueco realizado en la parte inferior.

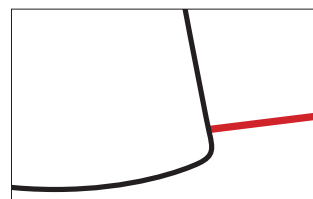

**OPTIONAL PREINSTALLED WIRING  
PREINSTALACIÓN DEL CABLEADO**

**IN0006**

Preinstalled wiring consists in the addition of the necessary mechanisms to integrate power systems in the table, so that wiring is hidden until the way out in the door. Necessary grommet are included and 3m cable (from the power system).

La preinstalación consiste en el montaje de los mecanismos necesarios para integrar el sistema de electrificación en la mesa, de modo que el cableado quede oculto hasta su salida por la base. Se incluyen los pasacables necesarios y 3 metros de cable (midiéndolo desde el sistema de conexiones).

**IN-SURFACE SOCKET POWERS  
TORRES DE CONEXIONES DENTRO DEL SOBRE**

Socket tower installed on the surface of the top. The hidden system is manually lifted when pressed. Valid for all Reverse bases. Available in silver, white or black.

Torre de conexiones instalada en la superficie del sobre. El sistema eléctrico oculto se alza manualmente al pulsarlo. Valido para todas las bases Reverse. Disponible en color plata, blanco o negro

**PS0716**

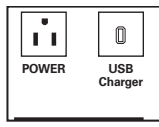
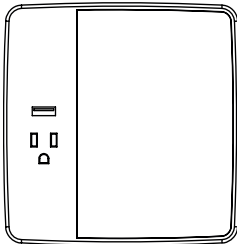

USA PLUG

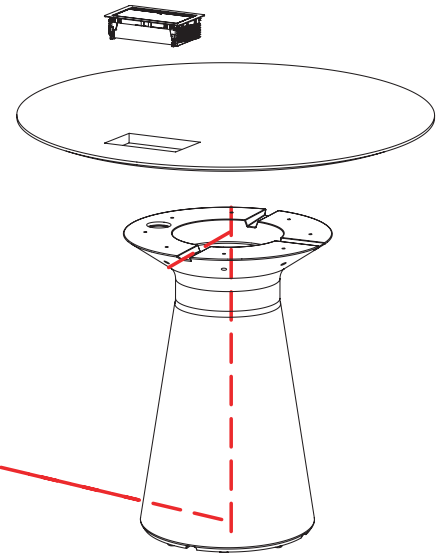

**1 POWER BOXES DISTRIBUTION DISTRIBUCIÓN DE SISTEMAS**

In tables with only one Reverse base power box can't be centered with the base. In tables with more than one base, by default power box is placed in the center of the table and in lengthwise direction.

En mesas con una sola base el sistema eléctrico iría instalado descentrado respecto a la base. En mesas con más de una base, por defecto la posición del sistema irá en el centro de la mesa y en sentido longitudinal.

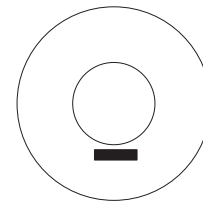

**2 WIRING MANAGEMENT GESTIÓN DEL CABLEADO**

The cable passes through an aluminum wire manager, keeping it hidden from the users.

El cable pasa a través de un perfil de aluminio que lo mantiene oculto.

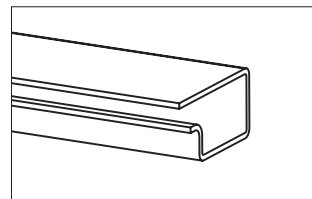

**3 CABLE WAY OUT SALIDA DE CABLEADO**

The cable way out can be performed directly from the leg itself through a hole in the lower part.

La salida del cable se realiza directamente desde la pata por un hueco realizado en la parte inferior.

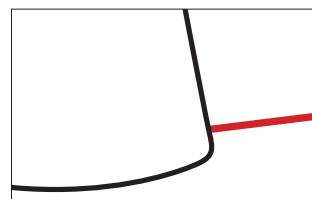

**OPTIONAL PREINSTALLED WIRING  
PREINSTALACIÓN DEL CABLEADO**

**IN0006**

Preinstalled wiring consists in the addition of the necessary mechanisms to integrate power systems in the table, so that wiring is hidden until the way out in the door. Necessary grommet are included and 3m cable (from the power system).

La preinstalación consiste en el montaje de los mecanismos necesarios para integrar el sistema de electrificación en la mesa, de modo que el cableado quede oculto hasta su salida por la base. Se incluyen los pasacables necesarios y 3 metros de cable (midiéndolo desde el sistema de conexiones).

**QI CHARGING POWER BOXES  
CAJAS DE CONEXIONES QI**

Inductive charging system that also has a plug and a 10W USB A charger. Available in black finish

Sistema de carga inductiva que ademas cuenta con un enchufe y un cargador USB A de 10W de potencia. Disponible en acabado negro.

**PS0717**

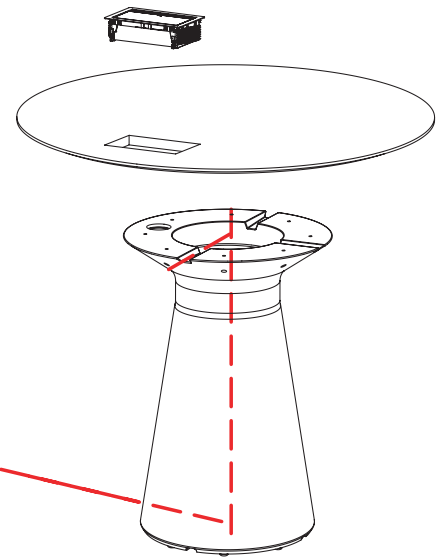
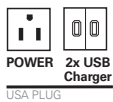
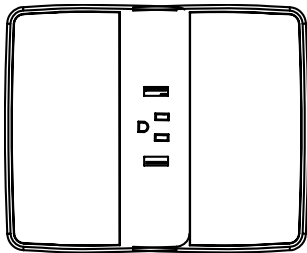

**1 POWER BOXES DISTRIBUTION DISTRIBUCIÓN DE SISTEMAS**

In tables with only one Reverse base power box can't be centered with the base. In tables with more than one base, by default power box is placed in the center of the table and in lengthwise direction.

En mesas con una sola base el sistema eléctrico iría instalado descentrado respecto a la base. En mesas con más de una base, por defecto la posición del sistema irá en el centro de la mesa y en sentido longitudinal.

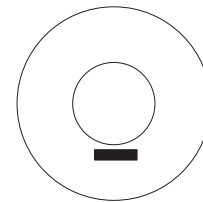

**2 WIRING MANAGEMENT GESTIÓN DEL CABLEADO**

The cable passes through an aluminum wire manager, keeping it hidden from the users.

El cable pasa a través de un perfil de aluminio que lo mantiene oculto.

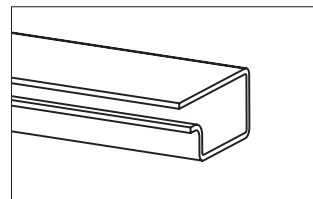

**3 CABLE WAY OUT SALIDA DE CABLEADO**

The cable way out can be performed directly from the leg itself through a hole in the lower part.

La salida del cable se realiza directamente desde la pata por un hueco realizado en la parte inferior.

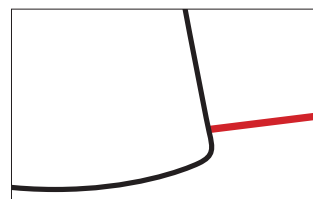

**OPTIONAL PREINSTALLED WIRING  
PREINSTALACIÓN DEL CABLEADO**

**IN0006**

Preinstalled wiring consists in the addition of the necessary mechanisms to integrate power systems in the table, so that wiring is hidden until the way out in the door. Necessary grommet are included and 3m cable (from the power system).

La preinstalación consiste en el montaje de los mecanismos necesarios para integrar el sistema de electrificación en la mesa, de modo que el cableado quede oculto hasta su salida por la base. Se incluyen los pasacables necesarios y 3 metros de cable (midiéndolo desde el sistema de conexiones).

**UNDER-TOP POWER BOXES  
CAJA DE CONEXIONES BAJO EL SOBRE**

Small under-top charging system consisting of 2 USB charging units with 10 W power. Finished in white or black.

Sistema de carga bajo el top, pequeño y compuesto de 2 USB a de carga de 10 W de potencia. Acabados en blanco o negro.

**PS0715**

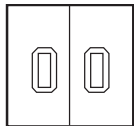
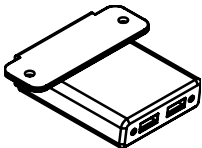

2 x USB  
Charger

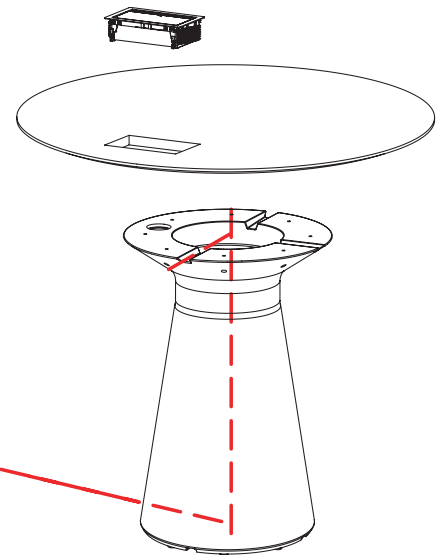

**1 POWER BOXES DISTRIBUTION DISTRIBUCIÓN DE SISTEMAS**

By standard, the arrangement of the system will be in the center of the long side of the table, in longitudinal direction and at 75 mm from the edge.

De serie, la disposición del sistema será en el centro del lado largo de la mesa, en sentido longitudinal y a 75 mm del canto.

**2 WIRING MANAGEMENT GESTIÓN DEL CABLEADO**

The cable passes through an aluminum wire manager, keeping it hidden from the users.

El cable pasa a través de un perfil de aluminio que lo mantiene oculto.

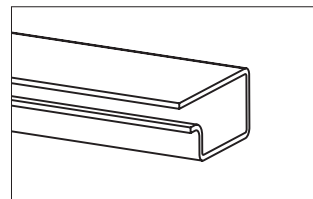

**3 CABLEWAY OUT SALIDA DE CABLEADO**

The cable way out can be performed directly from the leg itself through a hole in the lower part.

La salida del cable se realiza directamente desde la pata por un hueco realizado en la parte inferior.

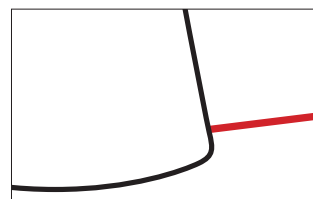

**OPTIONAL PREINSTALLED WIRING  
PREINSTALACIÓN DEL CABLEADO**

**IN0006**

Preinstalled wiring consists in the addition of the necessary mechanisms to integrate power systems in the table, so that wiring is hidden until the way out in the door. Necessary grommet are included and 3m cable (from the power system).

La preinstalación consiste en el montaje de los mecanismos necesarios para integrar el sistema de electrificación en la mesa, de modo que el cableado quede oculto hasta su salida por la base. Se incluyen los pasacables necesarios y 3 metros de cable (midiéndolo desde el sistema de conexiones).

**INTEGRATED POWER BOXES  
CAJAS DE CONEXIONES INTEGRADAS**

The integrated system has a cover of the same finish as the top, being perfectly integrated and only a small frame of black finish is always visible. The opening of the system is to both sides.

El sistema integrado lleva una tapeta del mismo acabado que el top, quedando perfectamente integrado y solo se ve un pequeño marco de acabado siempre negro. La apertura del sistema es hacia ambos lados.

**PS0723**

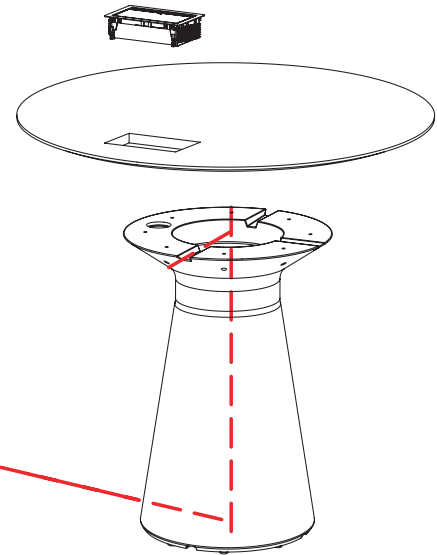
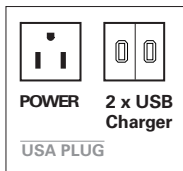
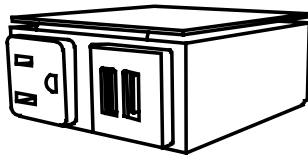

**1 POWER BOXES DISTRIBUTION DISTRIBUCIÓN DE SISTEMAS**

By standard, the position of the system will be in the central of the table, placed horizontally.

De serie, la disposición del sistema será en el centro de la mesa y en sentido longitudinal.

**2 WIRING MANAGEMENT GESTIÓN DEL CABLEADO**

The cable passes through an aluminum wire manager, keeping it hidden from the users.

El cable pasa a través de un perfil de aluminio que lo mantiene oculto.

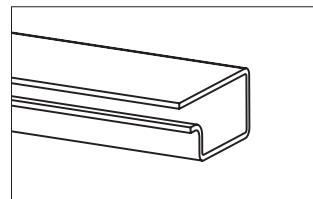

**3 CABLE WAY OUT SALIDA DE CABLEADO**

The cable way out can be performed directly from the leg itself through a hole in the lower part.

La salida del cable se realiza directamente desde la pata por un hueco realizado en la parte inferior.

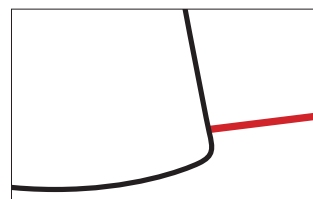

**OPTIONAL PREINSTALLED WIRING  
PREINSTALACIÓN DEL CABLEADO**

**IN0006**

Preinstalled wiring consists in the addition of the necessary mechanisms to integrate power systems in the table, so that wiring is hidden until the way out in the door. Necessary grommet are included and 3m cable (from the power system).

La preinstalación consiste en el montaje de los mecanismos necesarios para integrar el sistema de electrificación en la mesa, de modo que el cableado quede oculto hasta su salida por la base. Se incluyen los pasacables necesarios y 3 metros de cable (midiéndolo desde el sistema de conexiones).