



**Description**  
**Descripción**

Table program available with different types of bases and table tops. Base of aluminum legs available in different colors. Tops of different shapes and sizes, available in oak finish, lacquered, laminate, HPL, and glass. Available in 2 profile types, according to references. Connection box available.

Programa de mesas disponible con diferentes acabados de bases y sobres de mesa. Bases de patas de aluminio disponibles en diferentes colores. Sobres de tablero de diferentes medidas en acabado roble, lacado, laminado HPL, laminado TP y cristal. Disponible 2 tipos de perfil, según referencias. Disponible caja de conexiones.

<b>Wood Oak</b> <b>Madera Roble</b>	306	307	320	308	378	322	336	
	364	377	372	369	381	318		
<b>Laminate HPL</b> <b>Laminado HPL</b>	L200 White Blanco	L201 Black Negro	L300 Sand Arena	L302 Basalt grey Gris basalto	L301 Dark grey Gris oscuro	L205 Oak Roble	L204 Maple Arce	L207 Walnut Nogal
<b>Laminated TP</b> <b>Laminado TP</b>	L200 White Blanco	L201 Black Negro	L300 Sand Arena	L302 Basalt grey Gris basalto	L301 Dark grey Gris oscuro	L205 Oak Roble	L204 Maple Arce	L207 Walnut Nogal
<b>Wood lacquer</b> <b>Lacas Madera</b>	641	380	645L Sand Arena NCS S 2005-Y20R	646L Basalt grey Gris basalto NCS S 4005-Y20R	605L Dark grey Gris oscuro NCS S 6502-B	642L Cayenne red Rojo cayena RAL 3013	606L Yellow mustard Amarillo mostaza RAL 1005	
<b>Glass</b> <b>Cristal</b>	6000 White Blanco RAL 9003	6002 Black Negro RAL 9005	6012 Sand Arena NCS S 2005-Y20R	642L Basalt grey Gris basalto NCS S 4005-Y20R	605L Dark grey Gris oscuro NCS 6502-B	6006 Cayenne red Rojo cayena RAL 3013		
<b>Ultramatte</b> <b>Ultramate</b>	L310 White Blanco	L311 Black Negro						
<b>Linoleum</b> <b>Linóleo</b>	L315 Ivory Marfil	L316 Black Negro						
<b>M1 marble</b> <b>Mármol M1</b>	MARM Carrara white Blanco carrara							
<b>M3 marble</b> <b>Mármol M3</b>	CALACATTA Calacatta white Blanco calacatta							
<b>Aluminum</b> <b>Aluminio</b>	EPXB White Blanco RAL 9003	EPXA Sand Arena NCS S 2005-Y20R	EPSS Titanium grey Gris titanio RAL 7005	EPXN Black Negro RAL 9005	EPXM Anodized brown Anodizado marrón	EPXP Anodized silver Anodizado plata	CRBS Polished chrome Cromo brillo	ALUP Polished aluminum Aluminio pulido

**Intellectual property Propiedad intelectual**

All our collections are protected by international industrial design registries, designs patents, copyrights and intellectual Property laws. Unauthorized use of AW International Property is a criminal offence and can lead to prosecution.

Todas nuestras colecciones están protegidas por registros de diseño industrial, diseño de patente, copyright y derechos de propiedad intelectual todo el mundo. El uso no autorizado de los diseños y propiedad intelectual de AW supone un delito que puede ser sometido a acción judicial.



## ME13000

78.75 x 47.25 H29.25

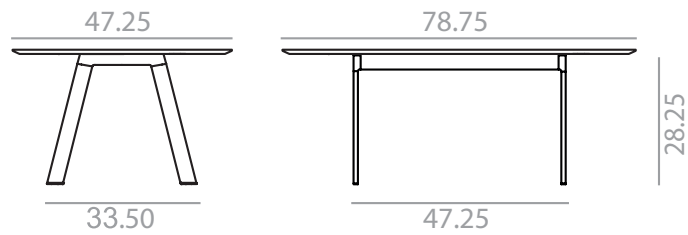

	Table top / Sobre							
	*Oak Roble	Lacquered Lacado	Laminate HPL Laminado HPL	LaminateTP Laminado TP	Low Iron Glass Cristal óptico	Linoleum Linóleo	Ultra-matte Ultramate	Ultra-matteTP Ultramate TP
	\$	\$	\$	\$	\$	\$	\$	\$
	7,967	6,350	8,451	8,115	10,231	9,595	9,643	9,285
lbs	175	175	175	175	175	175	175	175
1 box / bulto Ft	25'25	25'25	25'25	25'25	87'25	25'25	25'25	25'25

	Table top / Sobre					
	*Oak Roble	Lacquered Lacado	LaminateTP Laminado TP	Ultra-matteTP Ultramate TP	***M1 Marble Mármol M1	***M3 Marble Mármol M3
	\$	\$	\$	\$	\$	\$
	7,409	6,350	5,840	9,285	15,585	23,565
lbs	175	175	175	175	175	175
1 box / bulto Ft	25'25	25'25	25'25	25'25	87'25	87'25



\*Incremento por lacado mate y premium  
\*Matte lacquered and premium upcharge

| 389 |



\*\*\*Marble shiny upcharge  
Incremento por mármol brillo

| 68 |



Incremento patas de roble  
Oak legs upcharge

| 617 |



Incremento por aluminio pulido  
Polished aluminum upcharge

| 432 |

## ME13001

94.50 x 47.25 H29.25

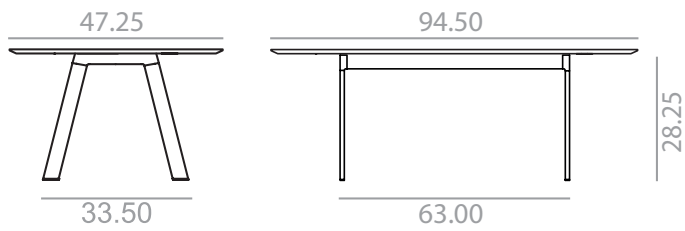

	Table top / Sobre							
	*Oak Roble	Lacquered Lacado	Laminate HPL Laminado HPL	LaminateTP Laminado TP	Low Iron Glass Cristal óptico	Linoleum Linóleo	Ultra-matte Ultramate	Ultra-matteTP Ultramate TP
	\$	\$	\$	\$	\$	\$	\$	\$
	8,689	7,081	8,911	8,618	11,665	10,081	10,138	9,822
lbs	206	206	206	206	206	206	206	206
1 box / bulto Ft	30	30	30	30	103	30	30	30

	Table top / Sobre					
	*Oak Roble	Lacquered Lacado	LaminateTP Laminado TP	Ultra-matteTP Ultramate TP	***M1 Marble Mármol M1	***M3 Marble Mármol M3
	\$	\$	\$	\$	\$	\$
	8,363	7,081	6,243	9,822	16,509	25,222
lbs	206	206	206	206	206	206
1 box / bulto Ft	30	30	30	30	103	103



\*Incremento por lacado mate y premium  
\*Matte lacquered and premium upcharge

| 429 |



\*\*\*Marble shiny upcharge  
Incremento por mármol brillo

| 68 |



Incremento patas de roble  
Oak legs upcharge

| 617 |



Incremento por aluminio pulido  
Polished aluminum upcharge

| 432 |

## ME13002

110.25 x 47.25 H29.25

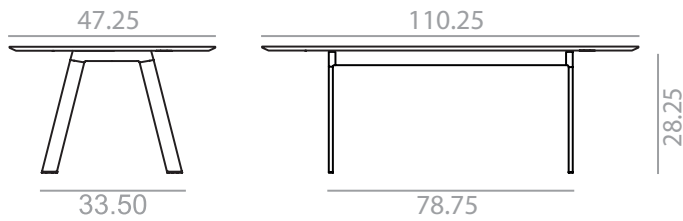

	Table top / Sobre							
	*Oak Roble	Lacquered Lacado	Laminate HPL Laminado HPL	LaminateTP Laminado TP	Low Iron Glass Cristal óptico	Linoleum Linóleo	Ultra-matte Ultramate	Ultra-matteTP Ultramate TP
	\$	\$	\$	\$	\$	\$	\$	\$
	10,534	7,820	11,119	10,547	13,123	12,767	12,802	12,065
lbs	234	234	234	234	234	234	234	234
1 box / bulto Ft	34'75	34'75	34'75	34'75	118'75	34'75	34'75	34'75

	Table top / Sobre					
	*Oak Roble	Lacquered Lacado	LaminateTP Laminado TP	Ultra-matteTP Ultramate TP	***M1 Marble Mármol M1	***M3 Marble Mármol M3
	\$	\$	\$	\$	\$	\$
	9,353	7,820	7,206	12,065	18,198	28,358
lbs	234	234	234	234	234	234
1 box / bulto Ft	34'75	34'75	34'75	34'75	118'75	118'75



\*Incremento por lacado mate y premium  
\*Matte lacquered and premium upcharge

| 469 |



\*\*\*Marble shiny upcharge  
Incremento por mármol brillo

| 68 |



Incremento patas de roble  
Oak legs upcharge

| 617 |



Incremento por aluminio pulido  
Polished aluminum upcharge

| 432 |

ME13003

118.25 x 59.00 H29.25

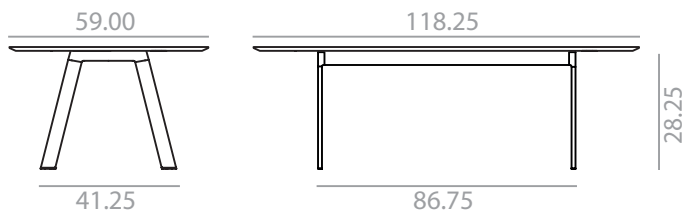

	Table top / Sobre							
	*Oak Roble	Lacquered Lacado	Laminate HPL Laminado HPL	LaminateTP Laminado TP	Low Iron Glass Cristal óptico	Linoleum Linóleo	Ultra-matte Ultramate	Ultra-matteTP Ultramate TP
	\$	\$	\$	\$	\$	\$	\$	\$
	11,793	9,137	11,795	11,300	15,961	13,088	13,497	12,932
lbs	294	294	294	294	294	294	294	294
1 box / bulto Ft	45'75	45'75	45'75	45'75	153'75	45'75	45'75	45'75

	Table top / Sobre					
	*Oak Roble	Lacquered Lacado	LaminateTP Laminado TP	Ultra-matteTP Ultramate TP	***M1 Marble Mármol M1	***M3 Marble Mármol M3
	\$	\$	\$	\$	\$	\$
	11,115	9,137	7,763	12,932	22,382	35,989
lbs	294	294	294	294	294	294
1 box / bulto Ft	45'75	45'75	45'75	45'75	153'75	153'75



\*Incremento por lacado mate y premium  
\*Matte lacquered and premium upcharge

| 674 |



\*\*\*Marble shiny upcharge  
Incremento por mármol brillo

| 68 |



Incremento patas de roble  
Oak legs upcharge

| 617 |



Incremento por aluminio pulido  
Polished aluminum upcharge

| 432 |

ME13004

138.00 x 59.00 H29.25

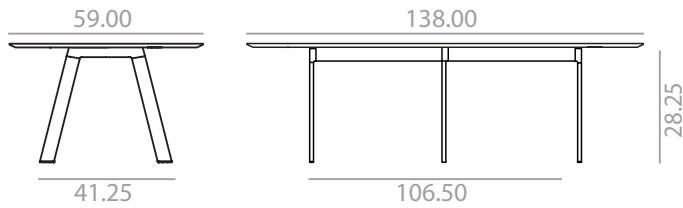

	Table top / Sobre							
	*Oak Roble	Lacquered Lacado	Laminate HPL Laminado HPL	LaminateTP Laminado TP	Low Iron Glass Cristal óptico	Linoleum Linóleo	Ultra-matte Ultramate	Ultra-matteTP Ultramate TP
	\$	\$	\$	\$	\$	\$	\$	\$
	16,830	12,116	15,671	15,055	20,193	17,877	19,304	17,208
lbs	466	466	466	466	525	466	466	466
1 box / bulto Ft	54'5	54'5	54'5	54'5	187'5	54'5	54'5	54'5

	Table top / Sobre					
	*Oak Roble	Lacquered Lacado	LaminateTP Laminado TP	Ultra-matteTP Ultramate TP	***M1 Marble Mármol M1	***M3 Marble Mármol M3
	\$	\$	\$	\$	\$	\$
	14,498	12,116	10,642	17,208	26,013	41,886
lbs	466	466	466	466	525	525
1 box / bulto Ft	54'5	54'5	54'5	54'5	187'5	187'5



\*Incremento por lacado mate y premium  
\*Matte lacquered and premium upcharge

| 788 |



\*\*\*Marble shiny upcharge  
Incremento por mármol brillo

| 68 |



Incremento patas de roble  
Oak legs upcharge

| 909 |



Incremento por aluminio pulido  
Polished aluminum upcharge

| 638 |

## ME13005

157.50 x 59.00 H29.25

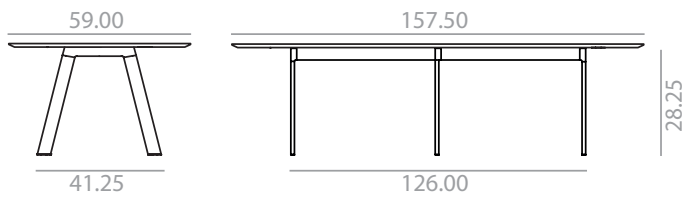

	Table top / Sobre							
	*Oak Roble	Lacquered Lacado	Laminate HPL Laminado HPL	Laminate TP Laminado TP	Low Iron Glass Cristal óptico	Linoleum Linóleo	Ultra-matte Ultramate	Ultra-matte TP Ultramate TP
	\$	\$	\$	\$	\$	\$	\$	\$
	18,733	13,999	17,800	16,942	24,252	20,325	21,951	19,403
lbs	305	305	305	305	318	305	305	305
1 box / bulto Ft	61'75	61'75	61'75	61'75	211'5	61'75	61'75	61'75

	Table top / Sobre					
	*Oak Roble	Lacquered Lacado	Laminate TP Laminado TP	Ultra-matte TP Ultramate TP	***M1 Marble Mármol M1	***M3 Marble Mármol M3
	\$	\$	\$	\$	\$	\$
	16,964	13,999	11,669	19,399	30,232	48,367
lbs	305	305	305	305	318	318
1 box / bulto Ft	61'75	61'75	61'75	61'75	211'5	211'5



\*Incremento por lacado mate y premium  
\*Matte lacquered and premium upcharge

| 900 |



\*\*\*Marble shiny upcharge  
Incremento por mármol brillo

| 68 |



Incremento patas de roble  
Oak legs upcharge

| 909 |



Incremento por aluminio pulido  
Polished aluminum upcharge

| 638 |

## ME13006

177.25 x 59.00 H29.25

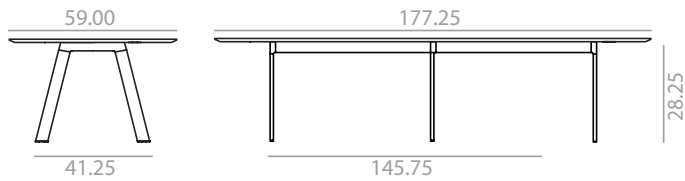

	Table top / Sobre							
	*Oak Roble	Lacquered Lacado	Laminate HPL Laminado HPL	Laminate TP Laminado TP	Low Iron Glass Cristal óptico	Linoleum Linóleo	Ultra-matte Ultramate	Ultra-matte TP Ultramate TP
	\$	\$	\$	\$	\$	\$	\$	\$
	20,068	15,235	19,846	18,831	26,704	22,402	24,036	21,491
lbs	305	305	305	305	499	305	305	305
1 box / bulto Ft	69'25	69'25	69'25	69'25	235'5	69'25	69'25	69'25

	Table top / Sobre					
	*Oak Roble	Lacquered Lacado	Laminate TP Laminado TP	Ultra-matte TP Ultramate TP	***M1 Marble Mármol M1	***M3 Marble Mármol M3
	\$	\$	\$	\$	\$	\$
	18,660	15,235	12,686	21,487	32,126	52,548
lbs	305	305	305	305	499	499
1 box / bulto Ft	69'25	69'25	69'25	69'25	235'5	235'5



\*Incremento por lacado mate y premium  
\*Matte lacquered and premium upcharge

| 1,010 |



\*\*\*Marble shiny upcharge  
Incremento por mármol brillo

| 68 |



Incremento patas de roble  
Oak legs upcharge

| 909 |



Incremento por aluminio pulido  
Polished aluminum upcharge

| 638 |

## ME13007

197.00 x 59.00 H29.25

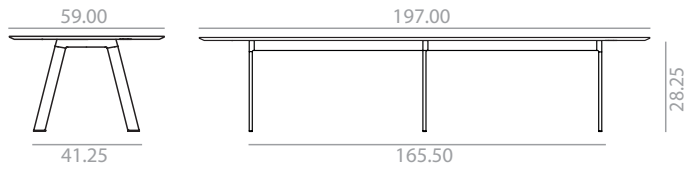

	Table top / Sobre							
	*Oak Roble	Lacquered Lacado	Laminate HPL Laminado HPL	Laminate TP Laminado TP	Low Iron Glass Cristal óptico	Linoleum Linóleo	Ultra-matte Ultramate	Ultra-matteTP Ultramate TP
	\$	\$	\$	\$	\$	\$	\$	\$
	21,410	16,495	21,913	20,743	27,727	24,496	26,123	24,839
lbs	565	565	565	565	322	565	565	565
1 box / bulto Ft	76'5	76'5	76'5	76'5	172	76'5	76'5	76'5

	Table top / Sobre					
	*Oak Roble	Lacquered Lacado	Laminate TP Laminado TP	Ultra-matteTP Ultramate TP	***M1 Marble M1	***M3 Marble M3
	\$	\$	\$	\$	\$	\$
	20,360	16,495	13,735	23,715	32,654	55,335
lbs	565	565	565	565	322	322
1 box / bulto Ft	76'5	76'5	76'5	76'5	172	172



\*Incremento por lacado mate y premium  
\*Matte lacquered and premium upcharge

| 1,123 |



\*\*\*Marble shiny upcharge  
Incremento por mármol brillo

| 68 |



Incremento patas de roble  
Oak legs upcharge

| 909 |



Incremento por aluminio pulido  
Polished aluminum upcharge

| 638 |

ME13008

216.75 x 59.00 H29.25

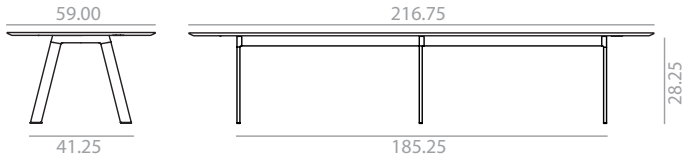

	Table top / Sobre							
	*Oak Roble	Lacquered Lacado	Laminate HPL Laminado HPL	LaminateTP Laminado TP	Low Iron Glass Cristal óptico	Linoleum Linóleo	Ultra-matte Ultramate	Ultra-matteTP Ultramate TP
	\$	\$	\$	\$	\$	\$	\$	\$
	22,868	17,727	22,648	21,570	31,645	25,268	26,896	24,751
lbs	349	349	349	349	322	349	349	349
1 box / bulto Ft	84	84	84	84	283'25	84	84	84

	Table top / Sobre					
	*Oak Roble	Lacquered Lacado	LaminateTP Laminado TP	Ultra-matteTP Ultramate TP	***M1 Marble Mármol M1	***M3 Marble Mármol M3
	\$	\$	\$	\$	\$	\$
	22,039	17,727	14,729	24,749	36,409	61,358
lbs	349	349	349	349	322	322
1 box / bulto Ft	84	84	84	84	283'25	283'25



\*Incremento por lacado mate y premium  
\*Matte lacquered and premium upcharge

| 1,235 |



\*\*\*Marble shiny upcharge  
Incremento por mármol brillo

| 68 |



Incremento patas de roble  
Oak legs upcharge

| 909 |



Incremento por aluminio pulido  
Polished aluminum upcharge

| 638 |

ME13009  
 Ø47.25 H29.25

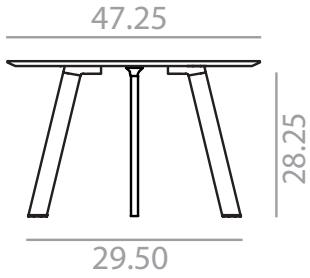

	Table top / Sobre							
	*Oak Roble	Lacquered Lacado	Laminate HPL Laminado HPL	Laminate TP Laminado TP	Low Iron Glass Cristal óptico	Linoleum Linóleo	Ultra-matte Ultramate	Ultra-matte TP Ultramate TP
	\$	\$	\$	\$	\$	\$	\$	\$
	5,028	4,078	5,050	5,123	6,830	5,831	5,684	5,950
lbs	89	89	89	89	89	89	89	89
1 box / bulto Ft	15'75	15'75	15'75	15'75	55'5	15'75	15'75	15'75

	Table top / Sobre					
	*Oak Roble	Lacquered Lacado	Laminate TP Laminado TP	Ultra-matte TP Ultramate TP	***M1 Marble Mármol M1	***M3 Marble Mármol M3
	\$	\$	\$	\$	\$	\$
	4,630	4,078	3,704	5,946	12,562	20,442
lbs	89	89	89	89	89	89
1 box / bulto Ft	15'75	15'75	15'75	15'75	47'75	15'75



\*Incremento por lacado mate y premium  
 \*Matte lacquered and premium upcharge

| 304 |



\*\*\*Marble shiny upcharge  
 Incremento por mármol brillo

| 68 |



Incremento patas de roble  
 Oak legs upcharge

| 617 |



Incremento por aluminio pulido  
 Polished aluminum upcharge

| 432 |

ME13010

Ø55.25 H29.25

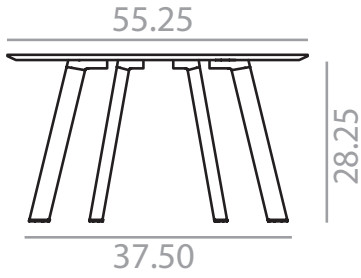

	Table top / Sobre							
	*Oak Roble	Lacquered Lacado	Laminate HPL Laminado HPL	LaminateTP Laminado TP	Low Iron Glass Cristal óptico	Linoleum Linóleo	Ultra-matte Ultramate	Ultra-matteTP Ultramate TP
	\$	\$	\$	\$	\$	\$	\$	\$
	6,311	4,745	6,205	6,197	8,372	6,933	7,338	7,169
lbs	111	111	111	111	111	111	111	111
1 box / bulto Ft	20'75	20'75	20'75	20'75	72'5	20'75	20'75	20'75

	Table top / Sobre					
	*Oak Roble	Lacquered Lacado	LaminateTP Laminado TP	Ultra-matteTP Ultramate TP	***M1 Marble Mármol M1	***M3 Marble Mármol M3
	\$	\$	\$	\$	\$	\$
	5,537	4,745	4,639	7,167	12,974	21,394
lbs	111	111	111	111	111	111
1 box / bulto Ft	20'75	20'75	20'75	20'75	72'5	72'5



\*Incremento por lacado mate y premium  
\*Matte lacquered and premium upcharge

| 343 |



\*\*\*Marble shiny upcharge  
Incremento por mármol brillo

| 68 |



Incremento patas de roble  
Oak legs upcharge

| 617 |



Incremento por aluminio pulido  
Polished aluminum upcharge

| 432 |

ME13100

55.25 x 31.50 H 35.50

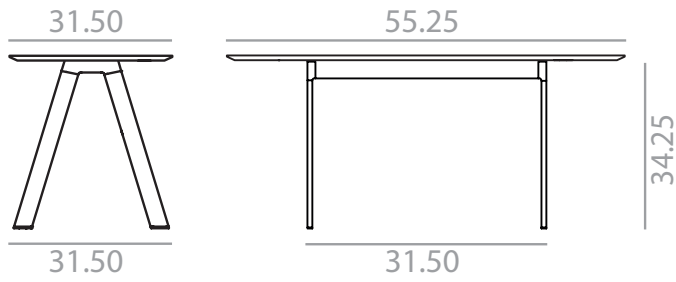

	Table top / Sobre							
	*Oak Roble	Lacquered Lacado	Laminate HPL Laminado HPL	Laminate TP Laminado TP	Low Iron Glass Cristal óptico	Linoleum Linóleo	Ultra-matte Ultramate	Ultra-matteTP UltramateTP
	\$	\$	\$	\$	\$	\$	\$	\$
	7,085	5,732	7,074	7,074	8,583	8,590	8,581	8,515
lbs	102	102	102	102	102	102	102	102
1 box / bulto Ft	12'5	12'5	12'5	12'5	45'25	12'5	12'5	12'5

	Table top / Sobre			
	*Oak Roble	Lacquered Lacado	Laminate TP Laminado TP	Ultra-matteTP UltramateTP
	\$	\$	\$	\$
	6,592	5,732	5,105	5,831
lbs	102	102	102	102
1 box / bulto Ft	12'5	12'5	12'5	12'5



\*Incremento por lacado mate y premium  
\*Matte lacquered and premium upcharge

| 311 |



\*\*\*Marble shiny upcharge  
Incremento por mármol brillo

| 68 |



Incremento patas de roble  
Oak legs upcharge

| 897 |



Incremento por aluminio pulido  
Polished aluminum upcharge

| 629 |

## ME13101

55.25 x 35.50 H 35.50

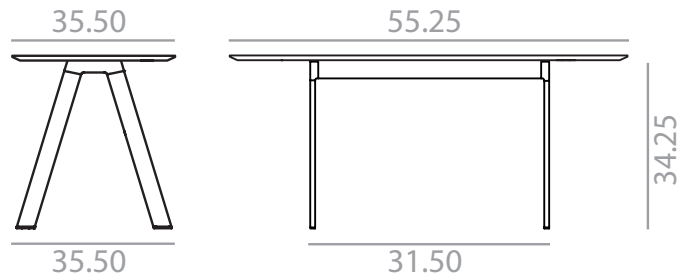

	Table top / Sobre							
	*Oak Roble	Lacquered Lacado	Laminate HPL Laminado HPL	LaminateTP Laminado TP	Low Iron Glass Cristal óptico	Linoleum Linóleo	Ultra-matte Ultramate	Ultra-matteTP Ultramate TP
	\$	\$	\$	\$	\$	\$	\$	\$
	7,120	5,763	7,107	7,138	8,742	8,651	8,640	8,568
lbs	109	109	109	109	109	109	109	109
1 box / bulto Ft	14	14	14	14	49'75	14	14	14

	Table top / Sobre			
	*Oak Roble	Lacquered Lacado	LaminateTP Laminado TP	Ultra-matteTP Ultramate TP
	\$	\$	\$	\$
	6,663	5,763	5,154	5,884
lbs	109	109	109	109
1 box / bulto Ft	14	14	14	14



\*Incremento por lacado mate y premium  
\*Matte lacquered and premium upcharge

| 325 |



\*\*\*Marble shiny upcharge  
Incremento por mármol brillo

| 68 |



Incremento patas de roble  
Oak legs upcharge

| 897 |



Incremento por aluminio pulido  
Polished aluminum upcharge

| 629 |

ME13102

55.25 x 39.50 H 35.50

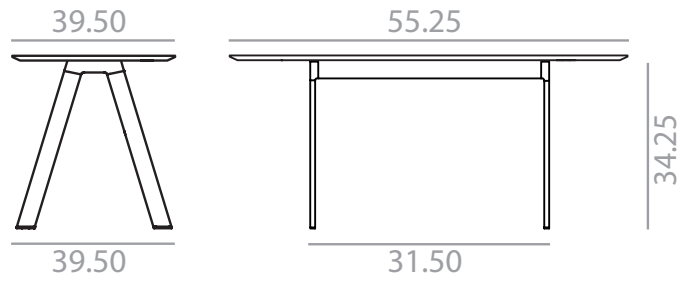

	Table top / Sobre							
	*Oak Roble	Lacquered Lacado	Laminate HPL Laminado HPL	LaminateTP Laminado TP	Low Iron Glass Cristal óptico	Linoleum Linóleo	Ultra-matte Ultramate	Ultra-matteTP Ultramate TP
	\$	\$	\$	\$	\$	\$	\$	\$
	7,147	5,825	7,136	7,202	8,909	8,706	8,698	8,623
lbs	126	126	126	126	126	126	126	126
1 box / bulto Ft	15'25	15'25	15'25	15'25	54'25	15'25	15'25	15'25

	Table top / Sobre			
	*Oak Roble	Lacquered Lacado	LaminateTP Laminado TP	Ultra-matteTP Ultramate TP
	\$	\$	\$	\$
	6,716	5,825	5,193	5,955
lbs	126	126	126	126
1 box / bulto Ft	15'25	15'25	15'25	15'25



\*Incremento por lacado mate y premium  
\*Matte lacquered and premium upcharge

| 338 |



\*\*\*Marble shiny upcharge  
Incremento por mármol brillo

| 68 |



Incremento patas de roble  
Oak legs upcharge

| 897 |



Incremento por aluminio pulido  
Polished aluminum upcharge

| 629 |

ME13103

71.00 x 31.50 H 35.50

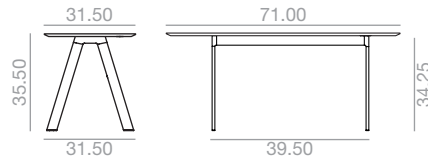

	Table top / Sobre							
	*Oak Roble	Lacquered Lacado	Laminate HPL Laminado HPL	LaminateTP Laminado TP	Low Iron Glass Cristal óptico	Linoleum Linóleo	Ultra-matte Ultramate	Ultra-matteTP Ultramate TP
	\$	\$	\$	\$	\$	\$	\$	\$
	7,446	5,860	7,131	7,417	8,986	8,715	8,852	8,115
lbs	137	137	137	137	137	137	137	137
1 box / bulto Ft	15'75	15'75	15'75	15'75	56'5	15'75	15'75	15'75

	Table top / Sobre			
	*Oak Roble	Lacquered Lacado	LaminateTP Laminado TP	Ultra-matteTP Ultramate TP
	\$	\$	\$	\$
	6,746	5,860	5,242	6,071
lbs	137	137	137	137
1 box / bulto Ft	15'75	15'75	15'75	15'75



\*Incremento por lacado mate y premium  
\*Matte lacquered and premium upcharge

| 351 |



\*\*\*Marble shiny upcharge  
Incremento por mármol brillo

| 68 |



Incremento patas de roble  
Oak legs upcharge

| 897 |



Incremento por aluminio pulido  
Polished aluminum upcharge

| 629 |

## ME13104

71.00 x 35.50 H 35.50

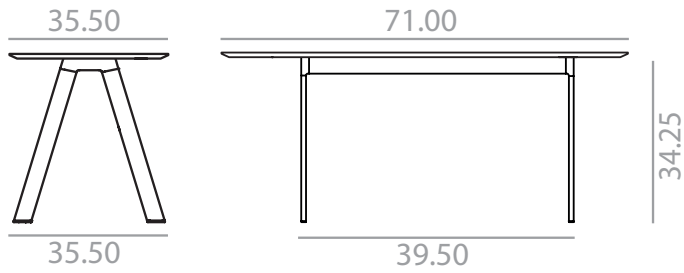

	Table top / Sobre							
	*Oak Roble	Lacquered Lacado	Laminate HPL Laminado HPL	Laminate TP Laminado TP	Low Iron Glass Cristal óptico	Linoleum Linóleo	Ultra-matte Ultramate	Ultra-matteTP Ultramate TP
	\$	\$	\$	\$	\$	\$	\$	\$
	7,483	5,904	7,895	7,488	9,157	8,777	8,913	8,845
lbs	146	146	146	146	146	146	146	146
1 box / bulto Ft	17'5	17'5	17'5	17'5	62'25	17'5	17'5	17'5

	Table top / Sobre			
	*Oak Roble	Lacquered Lacado	Laminate TP Laminado TP	Ultra-matteTP Ultramate TP
	\$	\$	\$	\$
	6,817	5,904	5,295	6,133
lbs	146	146	146	146
1 box / bulto Ft	17'5	17'5	17'5	17'5



SERIE  
600

\*Incremento por lacado  
mate y premium  
\*Matte lacquered and  
premium upcharge

| 364 |



\*\*\*Marble shiny upcharge  
Incremento por mármol  
brillo

| 68 |



Incremento patas de roble  
Oak legs upcharge

| 897 |



Incremento por aluminio  
pulido  
Polished aluminum  
upcharge

| 629 |

## ME13105

71.00 x 39.50 H 35.50

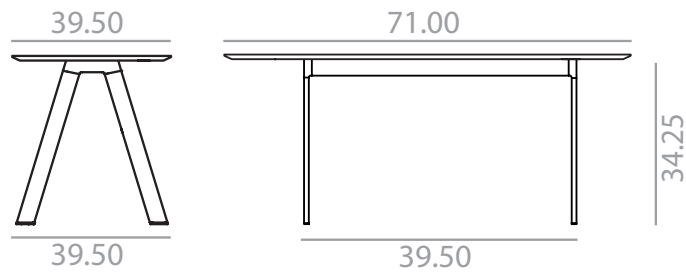

	Table top / Sobre							
	*Oak Roble	Lacquered Lacado	Laminate HPL Laminado HPL	LaminateTP Laminado TP	Low Iron Glass Cristal óptico	Linoleum Linóleo	Ultra-matte Ultramate	Ultra-matteTP Ultramate TP
	\$	\$	\$	\$	\$	\$	\$	\$
	7,514	5,974	7,934	7,554	9,333	8,834	8,979	8,904
lbs	164	164	164	164	164	164	164	164
1 box / bulto Ft	19'25	19'25	19'25	19'25	68	19'25	19'25	19'25

	Table top / Sobre			
	*Oak Roble	Lacquered Lacado	LaminateTP Laminado TP	Ultra-matteTP Ultramate TP
	\$	\$	\$	\$
	6,881	5,974	5,341	6,190
lbs	164	164	164	164
1 box / bulto Ft	19'25	19'25	19'25	19'25



SERIE 600

\*Incremento por lacado mate y premium  
\*Matte lacquered and premium upcharge

| 376 |



\*\*\*Marble shiny upcharge  
Incremento por mármol brillo

| 68 |



Incremento patas de roble  
Oak legs upcharge

| 897 |



Incremento por aluminio pulido  
Polished aluminum upcharge

| 629 |

## ME13106

94.50 x 31.50 H 35.50

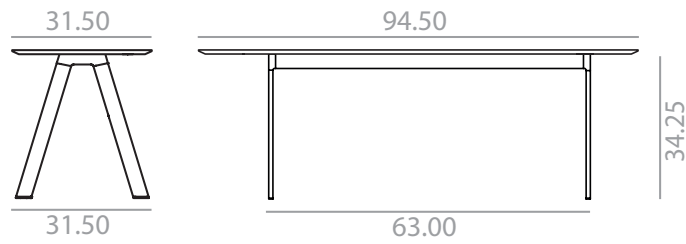

	Table top / Sobre							
	*Oak Roble	Lacquered Lacado	Laminate HPL Laminado HPL	LaminateTP Laminado TP	Low Iron Glass Cristal óptico	Linoleum Linóleo	Ultra-matte Ultramate	Ultra-matteTP Ultramate TP
	\$	\$	\$	\$	\$	\$	\$	\$
	8,130	6,478	8,315	7,870	11,104	9,254	9,712	9,626
lbs	177	177	177	177	177	177	177	177
1 box / bulto Ft	20'75	20'75	20'75	20'75	73'5	20'75	20'75	20'75

	Table top / Sobre			
	*Oak Roble	Lacquered Lacado	LaminateTP Laminado TP	Ultra-matteTP Ultramate TP
	\$	\$	\$	\$
	7,749	6,478	5,763	7,046
lbs	177	177	177	177
1 box / bulto Ft	20'75	20'75	20'75	20'75



\*Incremento por lacado mate y premium  
\*Matte lacquered and premium upcharge

| 389 |



\*\*\*Marble shiny upcharge  
Incremento por mármol brillo

| 68 |



Incremento patas de roble  
Oak legs upcharge

| 897 |



Incremento por aluminio pulido  
Polished aluminum upcharge

| 629 |

## ME13107

94.50 x 35.50 H 35.50

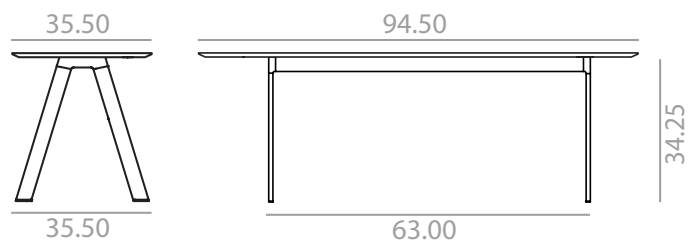

	Table top / Sobre							
	*Oak Roble	Lacquered Lacado	Laminate HPL Laminado HPL	LaminateTP Laminado TP	Low Iron Glass Cristal óptico	Linoleum Linóleo	Ultra-matte Ultramate	Ultra-matteTP Ultramate TP
	\$	\$	\$	\$	\$	\$	\$	\$
	8,176	6,562	8,361	7,961	12,472	9,324	9,782	9,696
lbs	190	190	190	190	190	190	190	190
1 box / bulto Ft	23	23	23	23	81	23	23	23

	Table top / Sobre			
	*Oak Roble	Lacquered Lacado	LaminateTP Laminado TP	Ultra-matteTP Ultramate TP
	\$	\$	\$	\$
	7,831	6,562	5,827	7,120
lbs	190	190	190	190
1 box / bulto Ft	23	23	23	23



SERIE 600

\*Incremento por lacado mate y premium  
\*Matte lacquered and premium upcharge

| 403 |



\*\*\*Marble shiny upcharge  
Incremento por mármol brillo

| 68 |



Incremento patas de roble  
Oak legs upcharge

| 897 |



Incremento por aluminio pulido  
Polished aluminum upcharge

| 629 |

## ME13108

94.50 x 39.50 H 35.50

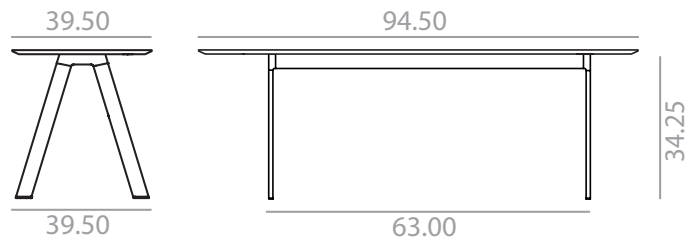

	Table top / Sobre							
	*Oak Roble	Lacquered Lacado	Laminate HPL Laminado HPL	LaminateTP Laminado TP	Low Iron Glass Cristal óptico	Linoleum Linóleo	Ultra-matte Ultramate	Ultra-matteTP Ultramate TP
	\$	\$	\$	\$	\$	\$	\$	\$
	8,225	6,647	8,403	8,055	10,818	9,397	9,855	9,769
lbs	219	219	219	219	219	219	219	219
1 box / bulto Ft	25'25	25'25	25'25	25'25	88'25	25'25	25'25	25'25

	Table top / Sobre			
	*Oak Roble	Lacquered Lacado	LaminateTP Laminado TP	Ultra-matteTP Ultramate TP
	\$	\$	\$	\$
	7,886	6,647	5,884	7,204
lbs	219	219	219	219
1 box / bulto Ft	25'25	25'25	25'25	25'25



\*Incremento por lacado mate y premium  
\*Matte lacquered and premium upcharge

| 416 |



\*\*\*Marble shiny upcharge  
Incremento por mármol brillo

| 68 |



Incremento patas de roble  
Oak legs upcharge

| 897 |



Incremento por aluminio pulido  
Polished aluminum upcharge

| 629 |

## ME13109

118.25 x 31.50 H 35.50

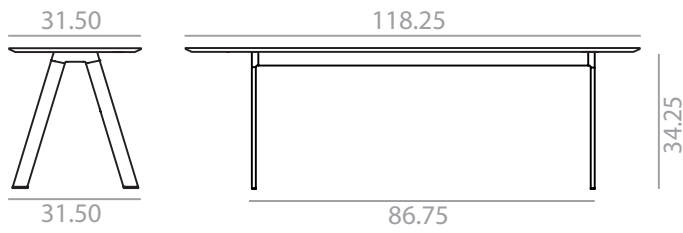

	Table top / Sobre							
	*Oak Roble	Lacquered Lacado	Laminate HPL Laminado HPL	LaminateTP Laminado TP	Low Iron Glass Cristal óptico	Linoleum Linóleo	Ultra-matte Ultramate	Ultra-matteTP Ultramate TP
	\$	\$	\$	\$	\$	\$	\$	\$
	9,866	7,248	10,380	9,756	11,953	11,960	11,823	11,740
lbs	234	234	234	234	234	234	234	234
1 box / bulto Ft	25'75	25'75	25'75	25'75	90'5	25'75	25'75	25'75

	Table top / Sobre			
	*Oak Roble	Lacquered Lacado	LaminateTP Laminado TP	Ultra-matteTP Ultramate TP
	\$	\$	\$	\$
	8,632	7,248	6,680	7,461
lbs	234	234	234	234
1 box / bulto Ft	25'75	25'75	25'75	25'75



\*Incremento por lacado mate y premium  
\*Matte lacquered and premium upcharge

| 429 |



\*\*\*Marble shiny upcharge  
Incremento por mármol brillo

| 68 |



Incremento patas de roble  
Oak legs upcharge

| 897 |



Incremento por aluminio pulido  
Polished aluminum upcharge

| 629 |

ME13110

118.25 x 35.50 H 35.50

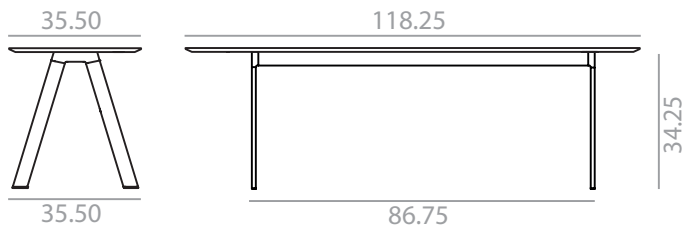

	Table top / Sobre							
	*Oak Roble	Lacquered Lacado	Laminate HPL Laminado HPL	Laminate TP Laminado TP	Low Iron Glass Cristal óptico	Linoleum Linóleo	Ultra-matte Ultramate	Ultra-matte TP Ultramate TP
	\$	\$	\$	\$	\$	\$	\$	\$
	9,923	7,345	10,435	9,852	11,522	12,041	11,896	11,817
lbs	234	234	234	234	234	234	234	234
1 box / bulto Ft	28'5	28'5	28'5	28'5	99'5	28'5	28'5	28'5

	Table top / Sobre			
	*Oak Roble	Lacquered Lacado	Laminate TP Laminado TP	Ultra-matte TP Ultramate TP
	\$	\$	\$	\$
	8,733	7,345	6,749	7,490
lbs	234	234	234	234
1 box / bulto Ft	28'5	28'5	28'5	28'5



\*Incremento por lacado mate y premium  
\*Matte lacquered and premium upcharge

| 402 |



\*\*\*Marble shiny upcharge  
Incremento por mármol brillo

| 68 |



Incremento patas de roble  
Oak legs upcharge

| 897 |



Incremento por aluminio pulido  
Polished aluminum upcharge

| 629 |

ME13111

118.25 x 39.50 H 35.50

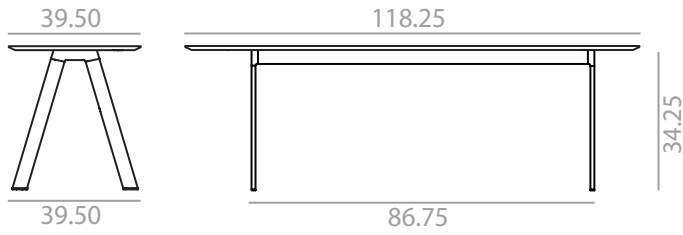

	Table top / Sobre							
	*Oak Roble	Lacquered Lacado	Laminate HPL Laminado HPL	Laminate TP Laminado TP	Low Iron Glass Cristal óptico	Linoleum Linóleo	Ultra-matte Ultramate	Ultra-matte TP Ultramate TP
	\$	\$	\$	\$	\$	\$	\$	\$
	9,982	7,448	10,495	9,960	12,426	12,120	11,982	11,898
lbs	234	234	234	234	234	234	234	234
1 box / bulto Ft	31'5	31'5	31'5	31'5	108'5	31'5	31'5	31'5

	Table top / Sobre			
	*Oak Roble	Lacquered Lacado	Laminate TP Laminado TP	Ultra-matte TP Ultramate TP
	\$	\$	\$	\$
	8,827	7,448	6,817	7,532
lbs	234	234	234	234
1 box / bulto Ft	31'5	31'5	31'5	31'5



\*Incremento por lacado mate y premium  
\*Matte lacquered and premium upcharge

| 414 |



\*\*\*Marble shiny upcharge  
Incremento por mármol brillo

| 68 |



Incremento patas de roble  
Oak legs upcharge

| 897 |



Incremento por aluminio pulido  
Polished aluminum upcharge

| 629 |

## ME13200

55.25 x 31.50 H43.25

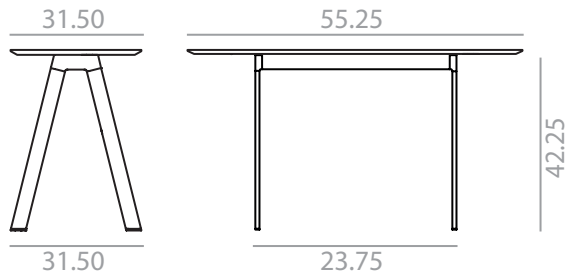

	Table top / Sobre							
	*Oak Roble	Lacquered Lacado	Laminate HPL Laminado HPL	Laminate TP Laminado TP	Low Iron Glass Cristal óptico	Linoleum Linóleo	Ultra-matte Ultramate	Ultra-matte TP Ultramate TP
	\$	\$	\$	\$	\$	\$	\$	\$
	7,158	5,801	7,142	7,145	8,665	8,665	8,660	8,581
lbs	102	102	102	102	102	102	102	102
1 box / bulto Ft	12'5	12'5	12'5	12'5	45'25	12'5	12'5	12'5

	Table top / Sobre			
	*Oak Roble	Lacquered Lacado	Laminate TP Laminado TP	Ultra-matte TP Ultramate TP
	\$	\$	\$	\$
	6,667	5,801	5,180	5,904
lbs	102	102	102	102
1 box / bulto Ft	12'5	12'5	12'5	12'5



\*Incremento por lacado mate y premium  
\*Matte lacquered and premium upcharge

| 311 |



\*\*\*Marble shiny upcharge  
Incremento por mármol brillo

| 68 |



Incremento patas de roble  
Oak legs upcharge

| 956 |



Incremento por aluminio pulido  
Polished aluminum upcharge

| 669 |

ME13201

55.25 x 35.50 H43.25

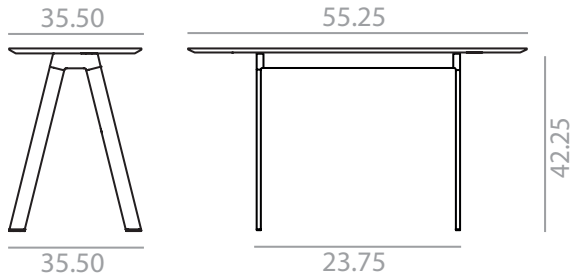

	Table top / Sobre							
	*Oak Roble	Lacquered Lacado	Laminate HPL Laminado HPL	LaminateTP Laminado TP	Low Iron Glass Cristal óptico	Linoleum Linóleo	Ultra-matte Ultramate	Ultra-matteTP Ultramate TP
	\$	\$	\$	\$	\$	\$	\$	\$
	7,184	5,838	7,178	7,213	8,825	8,717	8,713	8,640
lbs	109	109	109	109	109	109	109	109
1 box / bulto Ft	14	14	14	14	49'75	14	14	14

	Table top / Sobre			
	*Oak Roble	Lacquered Lacado	LaminateTP Laminado TP	Ultra-matteTP Ultramate TP
	\$	\$	\$	\$
	6,720	5,838	5,222	5,957
lbs	109	109	109	109
1 box / bulto Ft	14	14	14	14



\*Incremento por lacado mate y premium  
\*Matte lacquered and premium upcharge

| 343 |



\*\*\*Marble shiny upcharge  
Incremento por mármol brillo

| 68 |



Incremento patas de roble  
Oak legs upcharge

| 956 |



Incremento por aluminio pulido  
Polished aluminum upcharge

| 669 |

ME13202

55.25 x 39.50 H43.25

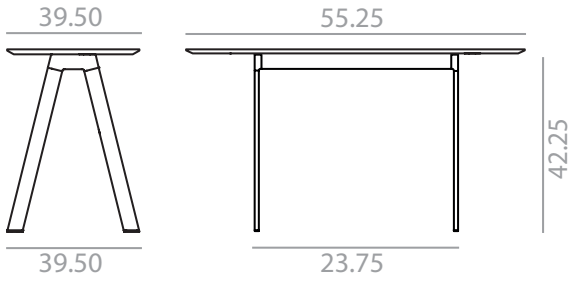

	Table top / Sobre							
	*Oak Roble	Lacquered Lacado	Laminate HPL Laminado HPL	LaminateTP Laminado TP	Low Iron Glass Cristal óptico	Linoleum Linóleo	Ultra-matte Ultramate	Ultra-matteTP Ultramate TP
	\$	\$	\$	\$	\$	\$	\$	\$
	7,217	5,895	7,206	7,274	8,984	8,777	8,768	8,698
lbs	115	115	115	115	115	115	115	115
1 box / bulto Ft	15'25	15'25	15'25	15'25	54'25	15'25	15'25	15'25

	Table top / Sobre			
	*Oak Roble	Lacquered Lacado	LaminateTP Laminado TP	Ultra-matteTP Ultramate TP
	\$	\$	\$	\$
	6,790	5,895	5,266	6,021
lbs	115	115	115	115
1 box / bulto Ft	15'25	15'25	15'25	15'25



\*Incremento por lacado mate y premium  
\*Matte lacquered and premium upcharge

| 338 |



\*\*\*Marble shiny upcharge  
Incremento por mármol brillo

| 68 |



Incremento patas de roble  
Oak legs upcharge

| 897 |



Incremento por aluminio pulido  
Polished aluminum upcharge

| 629 |

ME13203

71.00 x 31.50 H43.25

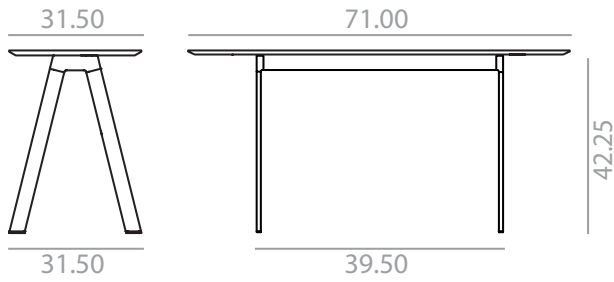

	Table top / Sobre							
	*Oak Roble	Lacquered Lacado	Laminate HPL Laminado HPL	Laminate TP Laminado TP	Low Iron Glass Cristal óptico	Linoleum Linóleo	Ultra-matte Ultramate	Ultra-matte TP Ultramate TP
	\$	\$	\$	\$	\$	\$	\$	\$
	7,519	5,935	7,200	7,494	9,056	8,786	8,924	8,185
lbs	126	126	126	126	126	126	126	126
1 box / bulto Ft	15'75	15'75	15'75	15'75	56'5	15'75	15'75	15'75

	Table top / Sobre			
	*Oak Roble	Lacquered Lacado	Laminate TP Laminado TP	Ultra-matte TP Ultramate TP
	\$	\$	\$	\$
	6,817	5,935	5,317	6,113
lbs	126	126	126	126
1 box / bulto Ft	15'75	15'75	15'75	15'75



\*Incremento por lacado mate y premium  
\*Matte lacquered and premium upcharge

| 351 |



\*\*\*Marble shiny upcharge  
Incremento por mármol brillo

| 68 |



Incremento patas de roble  
Oak legs upcharge

| 956 |



Incremento por aluminio pulido  
Polished aluminum upcharge

| 669 |

ME13204

71.00 x 35.50 H43.25

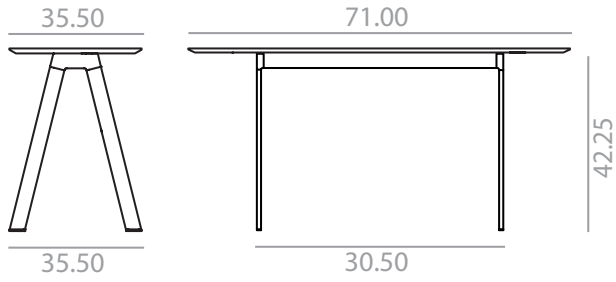

	Table top / Sobre							
	*Oak Roble	Lacquered Lacado	Laminate HPL Laminado HPL	Laminate TP Laminado TP	Low Iron Glass Cristal óptico	Linoleum Linóleo	Ultra-matte Ultramate	Ultra-matteTP Ultramate TP
	\$	\$	\$	\$	\$	\$	\$	\$
	7,547	5,977	7,969	7,558	9,234	8,852	8,986	8,913
lbs	137	137	137	137	137	137	137	137
1 box / bulto Ft	17'5	17'5	17'5	17'5	62'25	17'5	17'5	17'5

	Table top / Sobre			
	*Oak Roble	Lacquered Lacado	Laminate TP Laminado TP	Ultra-matteTP Ultramate TP
	\$	\$	\$	\$
	6,887	5,977	5,363	6,170
lbs	137	137	137	137
1 box / bulto Ft	17'5	17'5	17'5	17'5



\*Incremento por lacado mate y premium  
\*Matte lacquered and premium upcharge

| 364 |



\*\*\*Marble shiny upcharge  
Incremento por mármol brillo

| 68 |



Incremento patas de roble  
Oak legs upcharge

| 956 |



Incremento por aluminio pulido  
Polished aluminum upcharge

| 669 |

ME13205

71.00 x 39.50 H43.25

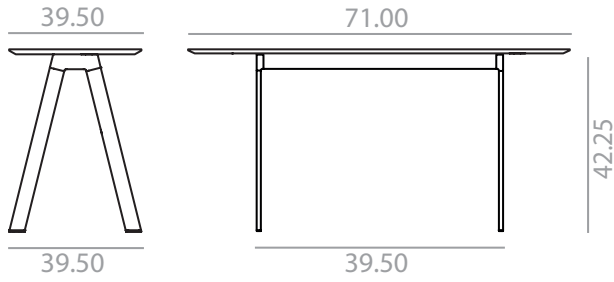

	Table top / Sobre							
	*Oak Roble	Lacquered Lacado	Laminate HPL Laminado HPL	Laminate TP Laminado TP	Low Iron Glass Cristal óptico	Linoleum Linóleo	Ultra-matte Ultramate	Ultra-matte TP Ultramate TP
	\$	\$	\$	\$	\$	\$	\$	\$
	7,587	6,047	8,005	7,629	9,419	8,909	9,052	8,979
lbs	146	146	146	146	146	146	146	146
1 box / bulto Ft	19'25	19'25	19'25	19'25	68	19'25	19'25	19'25

	Table top / Sobre			
	*Oak Roble	Lacquered Lacado	Laminate TP Laminado TP	Ultra-matte TP Ultramate TP
	\$	\$	\$	\$
	6,953	6,047	5,413	6,236
lbs	146	146	146	146
1 box / bulto Ft	19'25	19'25	19'25	19'25



\*Incremento por lacado mate y premium  
\*Matte lacquered and premium upcharge

| 376 |



\*\*\*Marble shiny upcharge  
Incremento por mármol brillo

| 68 |



Incremento patas de roble  
Oak legs upcharge

| 956 |



Incremento por aluminio pulido  
Polished aluminum upcharge

| 669 |

ME13206

94.50 x 31.50 H43.25

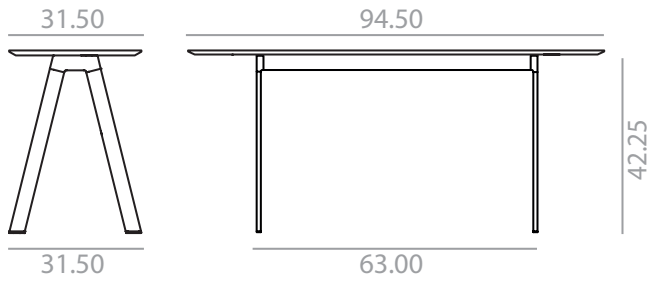

	Table top / Sobre							
	*Oak Roble	Lacquered Lacado	Laminate HPL Laminado HPL	LaminateTP Laminado TP	Low Iron Glass Cristal óptico	Linoleum Linóleo	Ultra-matte Ultramate	Ultra-matteTP Ultramate TP
	\$	\$	\$	\$	\$	\$	\$	\$
	8,203	6,553	8,390	7,941	9,892	9,333	9,782	9,703
lbs	164	164	164	164	164	164	164	164
1 box / bulto Ft	20'75	20'75	20'75	20'75	73'5	20'75	20'75	20'75

	Table top / Sobre			
	*Oak Roble	Lacquered Lacado	LaminateTP Laminado TP	Ultra-matteTP Ultramate TP
	\$	\$	\$	\$
	7,826	6,553	5,834	7,081
lbs	164	164	164	164
1 box / bulto Ft	20'75	20'75	20'75	20'75



\*Incremento por lacado mate y premium  
\*Matte lacquered and premium upcharge

| 389 |



\*\*\*Marble shiny upcharge  
Incremento por mármol brillo

| 68 |



Incremento patas de roble  
Oak legs upcharge

| 956 |



Incremento por aluminio pulido  
Polished aluminum upcharge

| 669 |

ME13207

94.50 x 35.50 H43.25

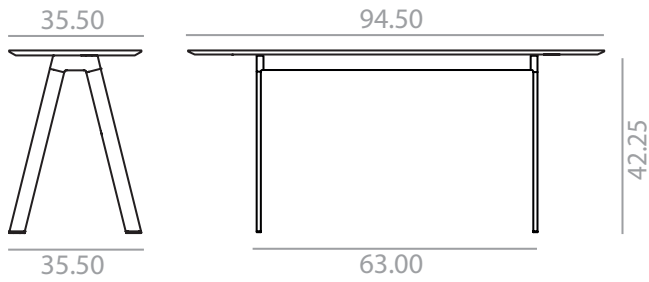

	Table top / Sobre							
	*Oak Roble	Lacquered Lacado	Laminate HPL Laminado HPL	LaminateTP Laminado TP	Low Iron Glass Cristal óptico	Linoleum Linóleo	Ultra-matte Ultramate	Ultra-matteTP Ultramate TP
	\$	\$	\$	\$	\$	\$	\$	\$
	8,247	6,639	8,431	8,033	10,686	9,404	9,855	9,771
lbs	177	177	177	177	177	177	177	177
1 box / bulto Ft	23	23	23	23	81	23	23	23

	Table top / Sobre			
	*Oak Roble	Lacquered Lacado	LaminateTP Laminado TP	Ultra-matteTP Ultramate TP
	\$	\$	\$	\$
	7,903	6,639	5,891	7,149
lbs	177	177	177	177
1 box / bulto Ft	23	23	23	23



\*Incremento por lacado mate y premium  
\*Matte lacquered and premium upcharge

403



\*\*\*Marble shiny upcharge  
Incremento por mármol brillo

68



Incremento patas de roble  
Oak legs upcharge

956



Incremento por aluminio pulido  
Polished aluminum upcharge

669

## ME13208

94.50 x 39.50 H43.25

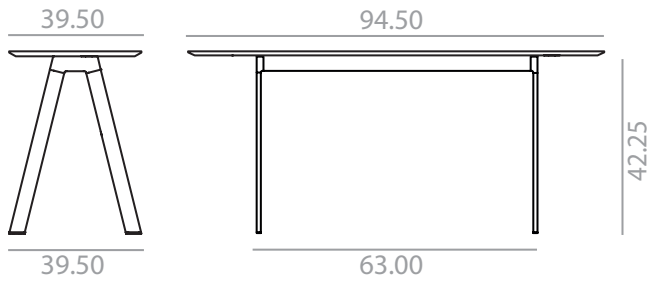

	Table top / Sobre							
	*Oak Roble	Lacquered Lacado	Laminate HPL Laminado HPL	LaminateTP Laminado TP	Low Iron Glass Cristal óptico	Linoleum Linóleo	Ultra-matte Ultramate	Ultra-matteTP Ultramate TP
	\$	\$	\$	\$	\$	\$	\$	\$
	8,295	6,718	8,478	8,119	11,617	9,474	9,923	9,839
lbs	190	190	190	190	190	190	190	190
1 box / bulto Ft	25'25	25'25	25'25	25'25	88'25	25'25	25'25	25'25

	Table top / Sobre			
	*Oak Roble	Lacquered Lacado	LaminateTP Laminado TP	Ultra-matteTP Ultramate TP
	\$	\$	\$	\$
	7,963	6,718	5,955	7,224
lbs	190	190	190	190
1 box / bulto Ft	25'25	25'25	25'25	25'25



\*Incremento por lacado mate y premium  
\*Matte lacquered and premium upcharge

| 416 |



\*\*\*Marble shiny upcharge  
Incremento por mármol brillo

| 68 |



Incremento patas de roble  
Oak legs upcharge

| 956 |



Incremento por aluminio pulido  
Polished aluminum upcharge

| 669 |

## ME13209

118.25 x 31.50 H43.25

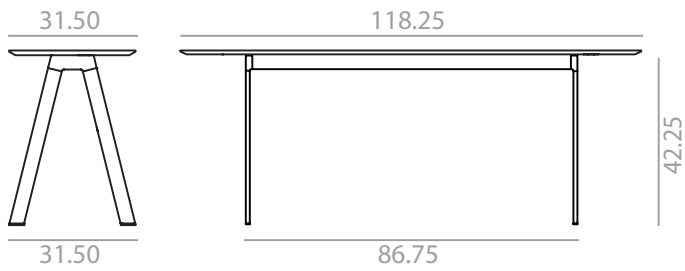

	Table top / Sobre							
	*Oak Roble	Lacquered Lacado	Laminate HPL Laminado HPL	Laminate TP Laminado TP	Low Iron Glass Cristal óptico	Linoleum Linóleo	Ultra-matte Ultramate	Ultra-matte TP Ultramate TP
	\$	\$	\$	\$	\$	\$	\$	\$
	9,936	7,323	10,451	9,830	12,037	12,030	11,891	11,808
lbs	203	203	203	203	203	203	203	203
1 box / bulto Ft	25'75	25'75	25'75	25'75	90'5	25'75	25'75	25'75

	Table top / Sobre			
	*Oak Roble	Lacquered Lacado	Laminate TP Laminado TP	Ultra-matte TP Ultramate TP
	\$	\$	\$	\$
	8,702	7,323	6,751	7,442
lbs	203	203	203	203
1 box / bulto Ft	25'75	25'75	25'75	25'75



\*Incremento por lacado mate y premium  
\*Matte lacquered and premium upcharge

| 429 |



\*\*\*Marble shiny upcharge  
Incremento por mármol brillo

| 68 |



Incremento patas de roble  
Oak legs upcharge

| 956 |



Incremento por aluminio pulido  
Polished aluminum upcharge

| 669 |

## ME13210

118.25 x 35.50 H43.25

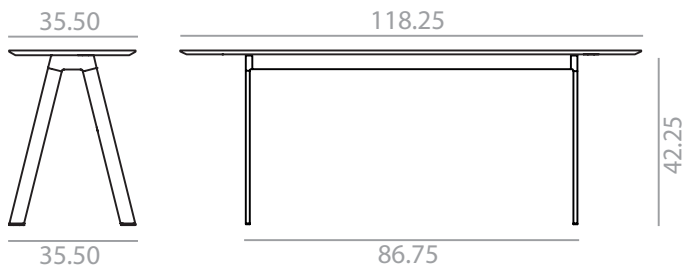

	Table top / Sobre							
	*Oak Roble	Lacquered Lacado	Laminate HPL Laminado HPL	LaminateTP Laminado TP	Low Iron Glass Cristal óptico	Linoleum Linóleo	Ultra-matte Ultramate	Ultra-matteTP Ultramate TP
	\$	\$	\$	\$	\$	\$	\$	\$
	9,995	7,411	10,508	9,932	12,272	12,118	11,973	11,887
lbs	219	219	219	219	219	219	219	219
1 box / bulto Ft	28'5	28'5	28'5	28'5	99'5	28'5	28'5	28'5

	Table top / Sobre			
	*Oak Roble	Lacquered Lacado	LaminateTP Laminado TP	Ultra-matteTP Ultramate TP
	\$	\$	\$	\$
	8,799	7,411	6,819	7,519
lbs	219	219	219	219
1 box / bulto Ft	28'5	28'5	28'5	28'5



\*Incremento por lacado mate y premium  
\*Matte lacquered and premium upcharge

442



\*\*\*Marble shiny upcharge  
Incremento por mármol brillo

68



Incremento patas de roble  
Oak legs upcharge

956



Incremento por aluminio pulido  
Polished aluminum upcharge

669

ME13211

118.25 x 39.50 H43.25

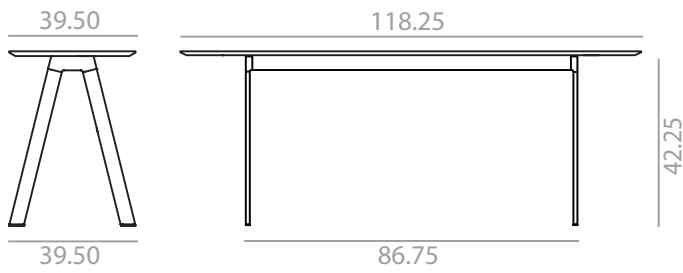

	Table top / Sobre							
	*Oak Roble	Lacquered Lacado	Laminate HPL Laminado HPL	LaminateTP Laminado TP	Low Iron Glass Cristal óptico	Linoleum Linóleo	Ultra-matte Ultramate	Ultra-matteTP Ultramate TP
	\$	\$	\$	\$	\$	\$	\$	\$
	10,057	7,516	10,558	10,033	12,499	12,191	12,056	11,971
lbs	234	234	234	234	234	234	234	234
1 box / bulto Ft	31'5	31'5	31'5	31'5	108'5	31'5	31'5	31'5

	Table top / Sobre			
	*Oak Roble	Lacquered Lacado	LaminateTP Laminado TP	Ultra-matteTP Ultramate TP
	\$	\$	\$	\$
	8,898	7,516	6,885	7,602
lbs	234	234	234	234
1 box / bulto Ft	31'5	31'5	31'5	31'5



\*Incremento por lacado mate y premium  
\*Matte lacquered and premium upcharge

455



\*\*\*Marble shiny upcharge  
Incremento por mármol brillo

68



Incremento patas de roble  
Oak legs upcharge







956



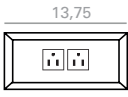

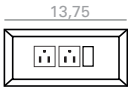
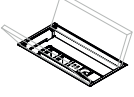
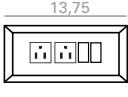
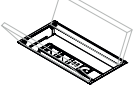
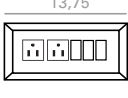
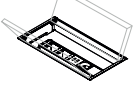
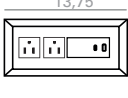

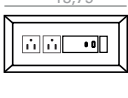
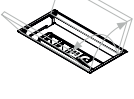
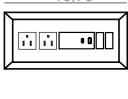
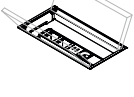
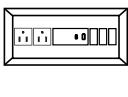
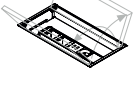
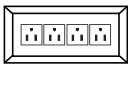
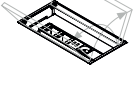
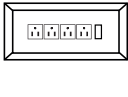
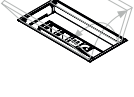
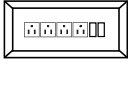
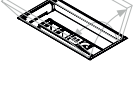
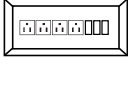

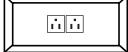



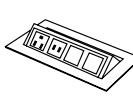
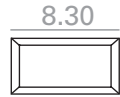
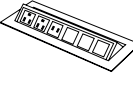
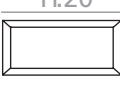
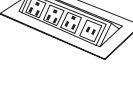
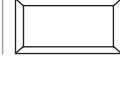

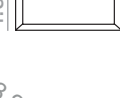
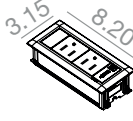

Incremento por aluminio pulido  
Polished aluminum upcharge

669

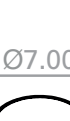
## PS-INTREGATED

		<b>PS3200</b>	<u>1,163</u>
		<b>PS3201</b>	<u>1,258</u>
		<b>PS3202</b>	<u>1,361</u>
		<b>PS3203</b>	<u>1,470</u>
		<b>PS3204</b>	<u>1,400</u>
		<b>PS3205</b>	<u>1,494</u>
		<b>PS3206</b>	<u>1,599</u>
		<b>PS3207</b>	<u>1,692</u>
		<b>PS3208</b>	<u>1,275</u>
		<b>PS3209</b>	<u>1,371</u>
		<b>PS3210</b>	<u>1,473</u>
		<b>PS3211</b>	<u>1,586</u>
		<b>PS3212</b>	<u>1,511</u>

## PS-IN SURFACE

		<b>PS0739</b>	<u>1,296</u>
		<b>PS0740</b>	<u>1,407</u>
		<b>PS0466</b>	<u>1,090</u>
		<b>PS0467</b>	<u>1,408</u>
		<b>PS0764</b>	<u>502</u>
		<b>PS0713</b>	<u>519</u>
		<b>PS0804</b>	<u>250</u>
<b>PS-QI</b>		<b>PS0714</b>	<u>530</u>
<b>PS-GROMMET 60 (ALU)</b>			<u>230</u>
<b>PS-GROMMET 60 (TP)</b>			<u>75</u>
<b>PS-GROMMET 80 (ALU)</b>			<u>312</u>
<b>PS-GROMMET 80 (TP)</b>			<u>88</u>
<b>PS-SNAKE</b>			<u>331</u>

**PS-INTEGRATED WITHOUT POWER SYSTEM**



**PS0232**

916

**PS-QI**

Ø7.00



**PS0714**

530

5.50



**PS0716**

469

5.50

7.25



**PS0717**

750

**CUT-OUT**

**CO1** Group 1 (oak, walnut, ash, lacquered, compacto, laminate, linoleum, ultramate, solid surface).. 187

**CO2** Grupo 2 (mármol, cristal, technical stone). 497

Unit price. It must be accompanied by a plan with measurement and position.

Precio unitario. Requiere ir acompañado de plano con medida y posición.

**Preinstalled (Optional) / Preinstalación (Opcional)**

**IN0006** 604

First installation / Primera instalación 604

Second and more installations / Segunda y más instalaciones 212

**INTEGRATED POWER BOXES  
CAJAS DE CONEXIONES INTEGRADAS**

The integrated system has a cover of the same nish as the top, being perfectly integrated and only a small frame of black finish is always visible. The opening of the system is to both sides.

El sistema integrado lleva una tapeta del mismo acabado que el top, quedando perfectamente integrado y solo se ve un pequeño marco de acabado siempre negro. La apertura del sistema es hacia ambos lados.

**PS3200** 1,163

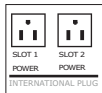

**PS3201** 1,258

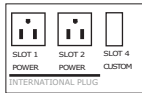

**PS3202** 1,361

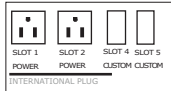

**PS3203** 1,470

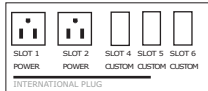

**PS3204** 1,400

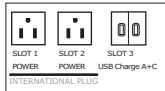

**PS3205** 1,494

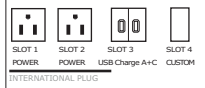

**PS3206** 1,599

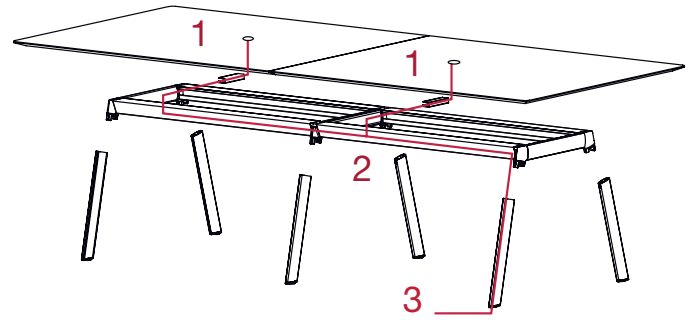
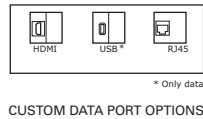
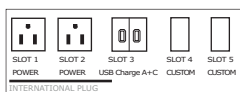

**1 POWER BOXES DISTRIBUTION DISTRIBUCIÓN DE SISTEMAS**

By standard, the position of the system will be in the central of the table, placed horizontally.

De serie, la disposición del sistema será en el centro de la mesa y en sentido longitudinal.

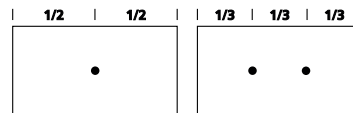

**2 WIRING MANAGEMENT GESTIÓN DEL CABLEADO**

The cable passes through an aluminum wire manager, keeping it hidden from the users.

El cable pasa a través de un perfil de aluminio que lo mantiene oculto.

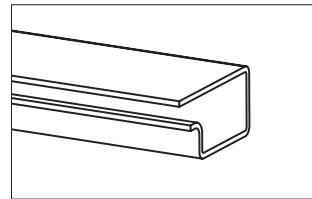

**3 CABLE WAY OUT SALIDA DE CABLEADO**

The cable way out can be performed directly from the leg itself through a hole in the lower part.

La salida del cable se realiza directamente desde la pata por un hueco realizado en la parte inferior.

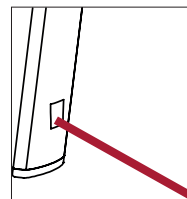

**INTEGRATED POWER BOXES  
CAJAS DE CONEXIONES INTEGRADAS**

The integrated system has a cover of the same nish as the top, being perfectly integrated and only a small frame of black finish is always visible. The opening of the system is to both sides.

El sistema integrado lleva una tapeta del mismo acabado que el top, quedando perfectamente integrado y solo se ve un pequeño marco de acabado siempre negro. La apertura del sistema es hacia ambos lados.

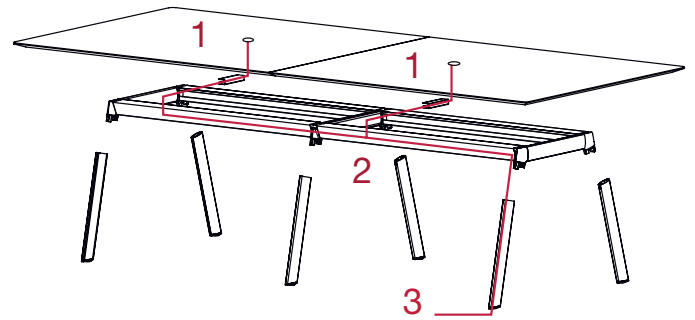

**PS3207** 1,692

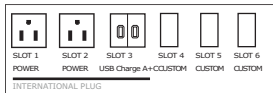

**PS3208** 1,275

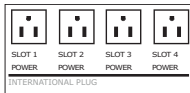
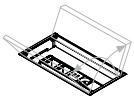

**PS3209** 1,371

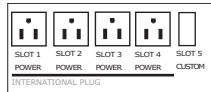

**PS3210** 1,473

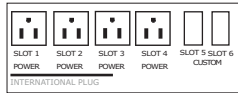

**PS3211** 1,586

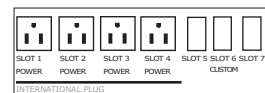

**PS3212** 1,511

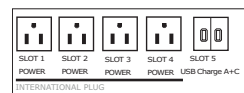

**1 POWER BOXES DISTRIBUTION DISTRIBUCIÓN DE SISTEMAS**

By standard, the position of the system will be in the central of the table, placed horizontally.

De serie, la disposición del sistema será en el centro de la mesa y en sentido longitudinal.

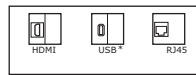
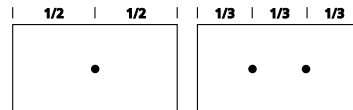

\* Only data

CUSTOM DATA PORT OPTIONS

**2 WIRING MANAGEMENT GESTIÓN DEL CABLEADO**

The cable passes through an aluminum wire manager, keeping it hidden from the users.

El cable pasa a través de un perfil de aluminio que lo mantiene oculto.

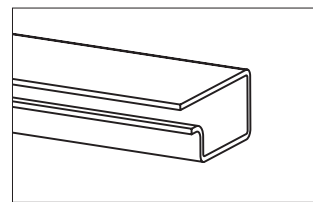

**3 CABLE WAY OUT SALIDA DE CABLEADO**

The cable way out can be performed directly from the leg itself through a hole in the lower part.

La salida del cable se realiza directamente desde la pata por un hueco realizado en la parte inferior.

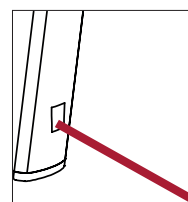

**OPTIONAL PREINSTALLED WIRING  
PREINSTALACIÓN DEL CABLEADO**

**IN0006**

Preinstalled wiring consists in the addition of the necessary mechanisms to integrate power systems in the table, so that wiring is hidden until the way out in the door. Necessary grommet are included and 3m cable (from the power system).

La preinstalación consiste en el montaje de los mecanismos necesarios para integrar el sistema de electrificación en la mesa, de modo que el cableado quede oculto hasta su salida por la base. Se incluyen los pasacables necesarios y 3 metros de cable (midiéndolo desde el sistema de conexiones).

**IN-SURFACE POWER BOXES  
CAJAS DE CONEXIONES DENTRO DEL SOBRE**

Aluminum power box mounted in the table top with a folding protective lid. It is served in anodized silver, white or black. There are two power system sizes available and data slots can be customized according to the below diagram.

Caja de conexiones de aluminio con tapa abatible instalada en la superficie del sobre. Se sirve en color anodizado plata, blanco o negro. Se ofrecen dos tamaños de caja de conexiones diferentes y con opciones de conectividad configurable según el diagrama inferior.

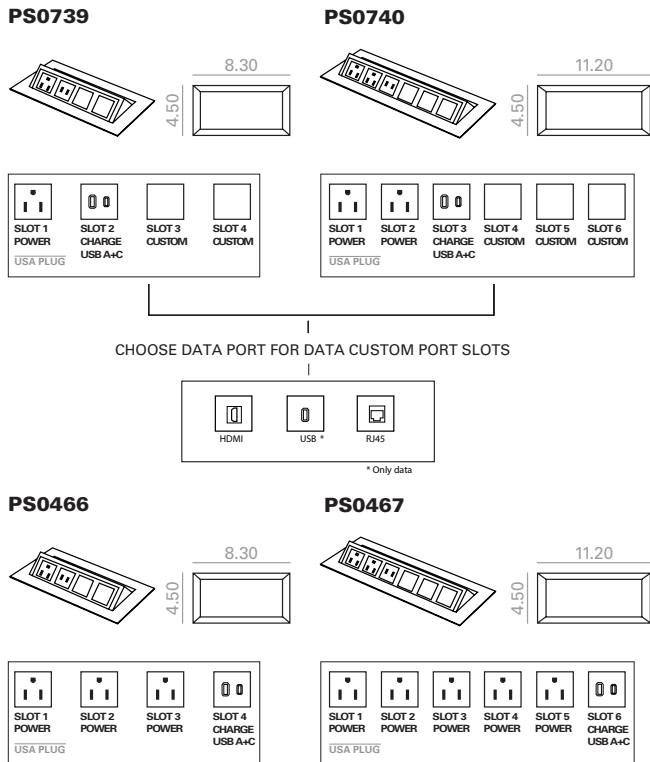

**OPTIONAL PREINSTALLED WIRING  
PREINSTALACIÓN DEL CABLEADO**

**IN0006**

Preinstalled wiring consists in the addition of the necessary mechanisms to integrate power systems in the table, so that wiring is hidden until the way out in the door. Necessary grommet are included and 3m cable (from the power system).

La preinstalación consiste en el montaje de los mecanismos necesarios para integrar el sistema de electrificación en la mesa, de modo que el cableado quede oculto hasta su salida por la base. Se incluyen los pasacables necesarios y 3 metros de cable (midiéndolo desde el sistema de conexiones).

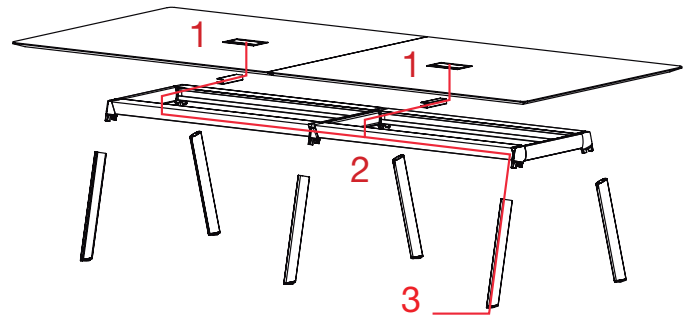

**1 POWER BOXES DISTRIBUTION DISTRIBUCIÓN DE SISTEMAS**

By standard, the position of the system will be in the central of the table, placed horizontally.

De serie, la disposición del sistema será en el centro de la mesa y en sentido longitudinal.

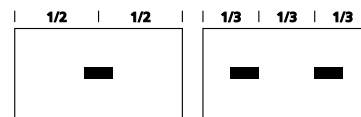

**2 WIRING MANAGEMENT GESTIÓN DEL CABLEADO**

The cable passes through an aluminum wire manager, keeping it hidden from the users.

El cable pasa a través de un perfil de aluminio que lo mantiene oculto.

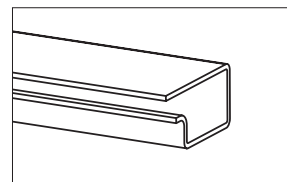

**3 CABLEWAY OUT SALIDA DE CABLEADO**

The cable way out can be performed directly from the leg itself through a hole in the lower part.

La salida del cable se realiza directamente desde la pata por un hueco realizado en la parte inferior.

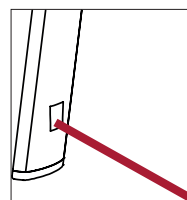

**IN-SURFACE POWER BOXES  
CAJAS DE CONEXIONES DENTRO DEL SOBRE**

Recessed junction box with a sleek design that makes it ideal for any work environment, ideal for any working environment. Composed of two powers and one USB A. Black finish.

Caja de conexiones encastrada con un diseño elegante que lo hace ideal para cualquier entorno de trabajo. Compuesto por dos powers y un USB A. Acabado en negro.

**PS0764**

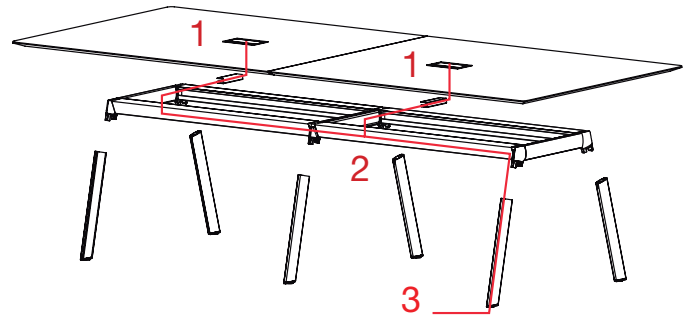
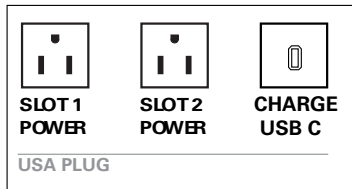
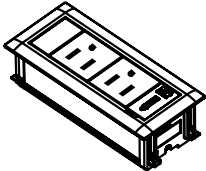

**1 POWER BOXES DISTRIBUTION DISTRIBUCIÓN DE SISTEMAS**

By standard, the position of the system will be in the central of the table, placed horizontally. When there are two system boxes, these will be separated 1/3 between them and placed horizontally.

De serie, la disposición del sistema será en el centro de la mesa y en sentido longitudinal. Cuando se disponga de dos sistemas, estos se colocarán con una separación de 1/3 de la longitud total de la mesa, y en sentido longitudinal.

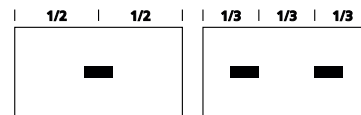

**OPTIONAL PREINSTALLED WIRING  
PREINSTALACIÓN DEL CABLEADO**

**IN0006**

Preinstalled wiring consists in the addition of the necessary mechanisms to integrate power systems in the table, so that wiring is hidden until the way out in the door. Necessary grommet are included and 3m cable (from the power system).

La preinstalación consiste en el montaje de los mecanismos necesarios para integrar el sistema de electrificación en la mesa, de modo que el cableado quede oculto hasta su salida por la base. Se incluyen los pasacables necesarios y 3 metros de cable (midiendo desde el sistema de conexiones).

**2 WIRING MANAGEMENT GESTIÓN DEL CABLEADO**

The cable passes through an aluminum wire manager, keeping it hidden from the users.

El cable pasa a través de un perfil de aluminio que lo mantiene oculto.

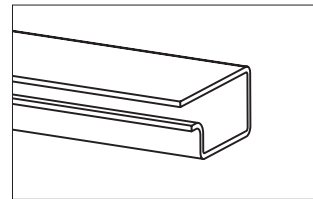

**3 CABLE WAY OUT SALIDA DE CABLEADO**

The cable way out can be performed directly from the leg itself through a hole in the lower part.

La salida del cable se realiza directamente desde la pata por un hueco realizado en la parte inferior.

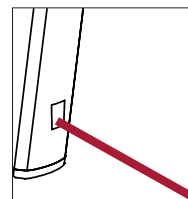

**IN-SURFACE POWER BOXES  
CAJAS DE CONEXIONES DENTRO DEL SOBRE**

Aluminum power box mounted in the table top with a folding protective lid. The lid rotates 360° to give full access to the system. It is served in anodized silver, black or white.

Caja de conexiones de aluminio con tapa instalada en la superficie del sobre. La tapa se gira 360° para dar acceso total al sistema. Se sirve en color anodizado plata, negro o blanco.

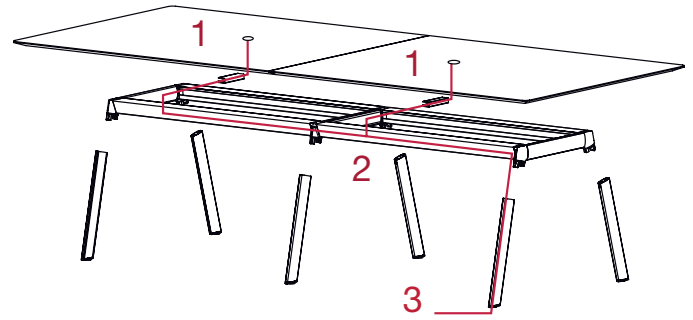

PS0713

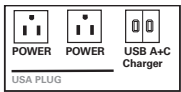
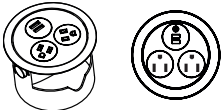

**1 POWER BOXES DISTRIBUTION DISTRIBUCIÓN DE SISTEMAS**

By standard, the arrangement of the system will be in the center of the table

De serie, la disposición del sistema será en el centro de la mesa.

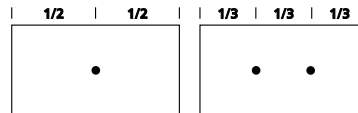

**2 WIRING MANAGEMENT GESTIÓN DEL CABLEADO**

The cable passes through an aluminum wire manager, keeping it hidden from the users.

El cable pasa a través de un perfil de aluminio que lo mantiene oculto.

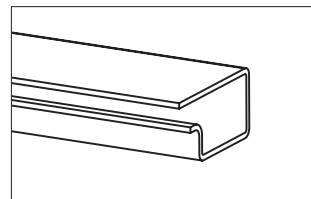

**OPTIONAL PREINSTALLED WIRING  
PREINSTALACIÓN DEL CABLEADO**

IN0006

Preinstalled wiring consists in the addition of the necessary mechanisms to integrate power systems in the table, so that wiring is hidden until the way out in the door. Necessary grommet are included and 3m cable (from the power system).

La preinstalación consiste en el montaje de los mecanismos necesarios para integrar el sistema de electrificación en la mesa, de modo que el cableado quede oculto hasta su salida por la base. Se incluyen los pasacables necesarios y 3 metros de cable (midiendo desde el sistema de conexiones).

**3 CABLE WAY OUT SALIDA DE CABLEADO**

The cable way out can be performed directly from the leg itself through a hole in the lower part.

La salida del cable se realiza directamente desde la pata por un hueco realizado en la parte inferior.

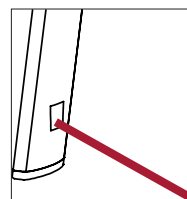

**IN-SURFACE POWER BOXES  
CAJAS DE CONEXIONES DENTRO DEL SOBRE**

Compact and individual charging system with 5v and 2A of power can charge any brand of mobile phones, the ports will be A + C. Available in two finishes: black or white.

Sistema de carga compacto e individual con 5v y 2A de potencia puede cargar teléfonos móviles de cualquier marca, los puertos serán A + C. Disponible en dos acabados: negro o blanco

**PS0804**

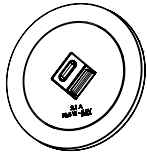

USB charger A+C

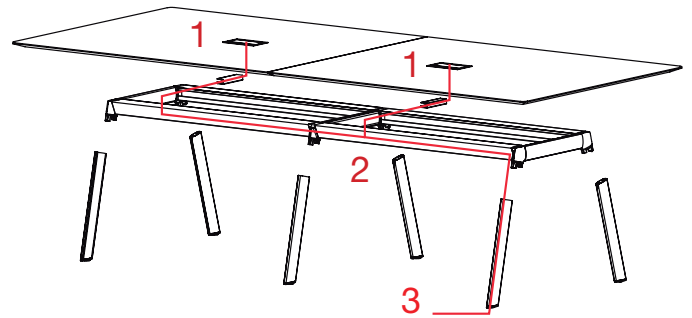

**1 POWER BOXES DISTRIBUTION DISTRIBUCIÓN DE SISTEMAS**

By standard, the position of the system will be in the central of the table, placed horizontally. When there are two system boxes, these will be separated 1/3 between them and placed horizontally.

De serie, la disposición del sistema será en el centro de la mesa y en sentido longitudinal. Cuando se disponga de dos sistemas, estos se colocarán con una separación de 1/3 de la longitud total de la mesa, y en sentido longitudinal.

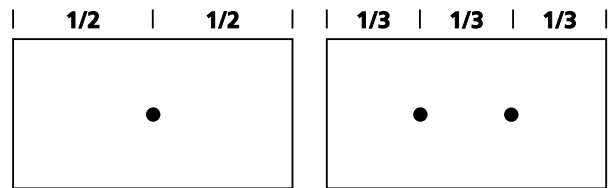

**2 WIRING MANAGEMENT GESTIÓN DEL CABLEADO**

The cable passes through an aluminum wire manager, keeping it hidden from the users.

El cable pasa a través de un perfil de aluminio que lo mantiene oculto.

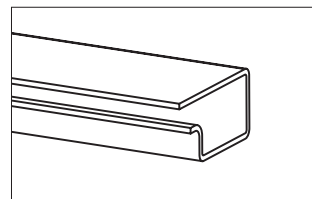

**OPTIONAL PREINSTALLED WIRING  
PREINSTALACIÓN DEL CABLEADO**

**IN0006**

Preinstalled wiring consists in the addition of the necessary mechanisms to integrate power systems in the table, so that wiring is hidden until the way out in the door. Necessary grommet are included and 3m cable (from the power system).

La preinstalación consiste en el montaje de los mecanismos necesarios para integrar el sistema de electrificación en la mesa, de modo que el cableado quede oculto hasta su salida por la base. Se incluyen los pasacables necesarios y 3 metros de cable (midiendo desde el sistema de conexiones).

**3 CABLE WAY OUT SALIDA DE CABLEADO**

The cable way out can be performed directly from the leg itself through a hole in the lower part.

La salida del cable se realiza directamente desde la pata por un hueco realizado en la parte inferior.

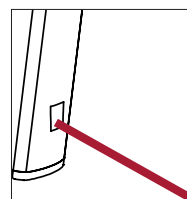

**QI CHARGING POWER BOXES  
CAJAS DE CONEXIONES QI**

The inductive charging station allows us to charge any device that has Qi technology built in. With a wide charging surface, just leave the device centered over the corresponding area. Available in black finish.

La estación de carga inductiva nos permite cargar cualquier dispositivo que tenga la tecnología Qi incorporada. Con una superficie de carga amplia, solo se debe dejar el dispositivo centrado sobre el area correspondiente. Dsponible en acabado negro.

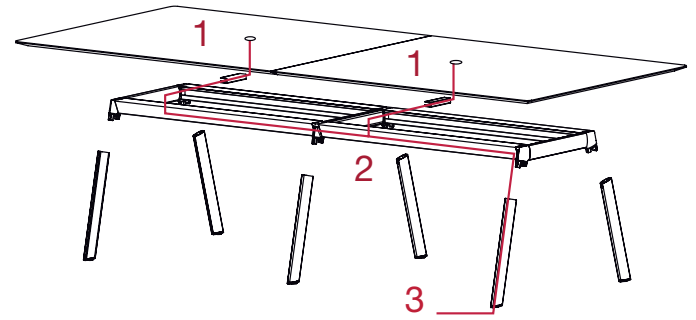

**PS0714**

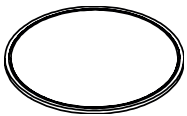

**1 POWER BOXES DISTRIBUTION DISTRIBUCIÓN DE SISTEMAS**

By standard, the position of the system will be in the central of the table, placed horizontally. When there are two system boxes, these will be separated 1/3 between them and placed horizontally.

De serie, la disposición del sistema será en el centro de la mesa y en sentido longitudinal. Cuando se disponga de dos sistemas, estos se colocarán con una separación de 1/3 de la longitud total de la mesa, y en sentido longitudinal.

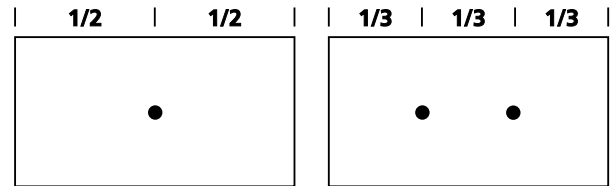

**2 WIRING MANAGEMENT GESTIÓN DEL CABLEADO**

The cable passes through an aluminum wire manager, keeping it hidden from the users.

El cable pasa a través de un perfil de aluminio que lo mantiene oculto.

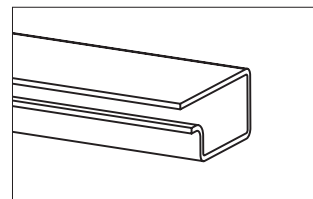

**OPTIONAL PREINSTALLED WIRING  
PREINSTALACIÓN DEL CABLEADO**

**IN0006**

Preinstalled wiring consists in the addition of the necessary mechanisms to integrate power systems in the table, so that wiring is hidden until the way out in the door. Necessary grommet are included and 3m cable (from the power system).

La preinstalación consiste en el montaje de los mecanismos necesarios para integrar el sistema de electrificación en la mesa, de modo que el cableado quede oculto hasta su salida por la base. Se incluyen los pasacables necesarios y 3 metros de cable (midiendo desde el sistema de conexiones).

**3 CABLE WAY OUT SALIDA DE CABLEADO**

The cable way out can be performed directly from the leg itself through a hole in the lower part.

La salida del cable se realiza directamente desde la pata por un hueco realizado en la parte inferior.

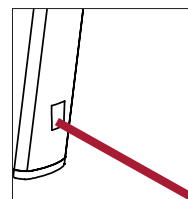

**QI CHARGING POWER BOXES  
CAJAS DE CONEXIONES QI**

Inductive charging system that also has a plug and a 10W USB A charger. Available in black finish

Sistema de carga inductiva que además cuenta con un enchufe y un cargador USB A de 10W de potencia. Disponible en acabado negro.

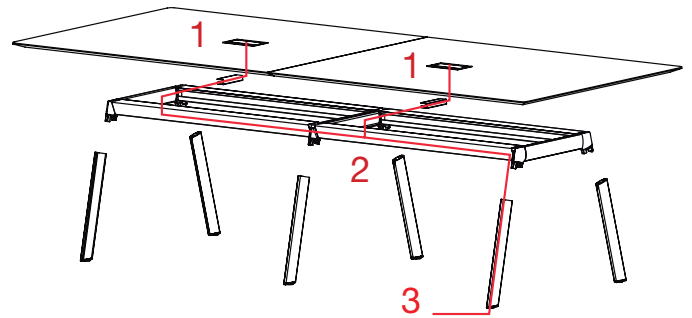

**PS0716**

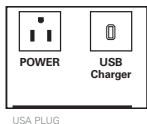
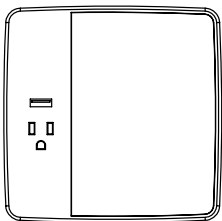

**1 POWER BOXES DISTRIBUTION DISTRIBUCIÓN DE SISTEMAS**

By standard, the position of the system will be in the central of the table, placed horizontally. When there are two system boxes, these will be separated 1/3 between them and placed horizontally.

De serie, la disposición del sistema será en el centro de la mesa y en sentido longitudinal. Cuando se disponga de dos sistemas, estos se colocarán con una separación de 1/3 de la longitud total de la mesa, y en sentido longitudinal.



**2 WIRING MANAGEMENT GESTIÓN DEL CABLEADO**

The cable passes through an aluminum wire manager, keeping it hidden from the users.

El cable pasa a través de un perfil de aluminio que lo mantiene oculto.

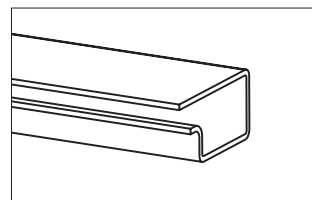

**3 CABLE WAY OUT SALIDA DE CABLEADO**

The cable way out can be performed directly from the leg itself through a hole in the lower part.

La salida del cable se realiza directamente desde la pata por un hueco realizado en la parte inferior.

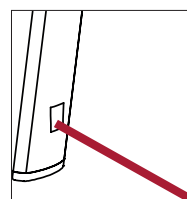

**OPTIONAL PREINSTALLED WIRING  
PREINSTALACIÓN DEL CABLEADO**

**IN0006**

Preinstalled wiring consists in the addition of the necessary mechanisms to integrate power systems in the table, so that wiring is hidden until the way out in the door. Necessary grommet are included and 3m cable (from the power system).

La preinstalación consiste en el montaje de los mecanismos necesarios para integrar el sistema de electrificación en la mesa, de modo que el cableado quede oculto hasta su salida por la base. Se incluyen los pasacables necesarios y 3 metros de cable (midiéndolo desde el sistema de conexiones).

**QI CHARGING POWER BOXES  
CAJAS DE CONEXIONES QI**

Inductive charging system that also has a plug and a 10W USB A charger. Available in black finish

Sistema de carga inductiva que además cuenta con un enchufe y un cargador USB A de 10W de potencia. Disponible en acabado negro.

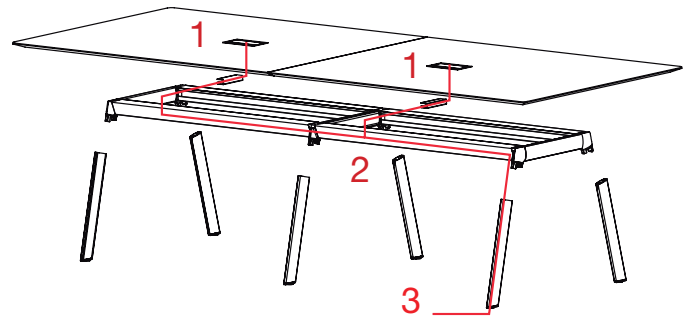

**PS0717**

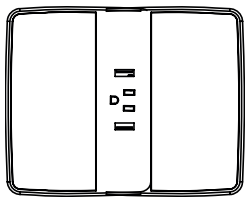

**1 POWER BOXES DISTRIBUTION DISTRIBUCIÓN DE SISTEMAS**

By standard, the position of the system will be in the central of the table, placed horizontally. When there are two system boxes, these will be separated 1/3 between them and placed horizontally.

De serie, la disposición del sistema será en el centro de la mesa y en sentido longitudinal. Cuando se disponga de dos sistemas, estos se colocarán con una separación de 1/3 de la longitud total de la mesa, y en sentido longitudinal.



**2 WIRING MANAGEMENT GESTIÓN DEL CABLEADO**

The cable passes through an aluminum wire manager, keeping it hidden from the users.

El cable pasa a través de un perfil de aluminio que lo mantiene oculto.

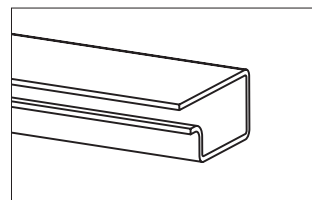

**3 CABLE WAY OUT SALIDA DE CABLEADO**

The cable way out can be performed directly from the leg itself through a hole in the lower part.

La salida del cable se realiza directamente desde la pata por un hueco realizado en la parte inferior.

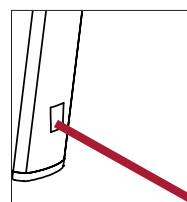

**OPTIONAL PREINSTALLED WIRING  
PREINSTALACIÓN DEL CABLEADO**

**IN0006**

Preinstalled wiring consists in the addition of the necessary mechanisms to integrate power systems in the table, so that wiring is hidden until the way out in the door. Necessary grommet are included and 3m cable (from the power system).

La preinstalación consiste en el montaje de los mecanismos necesarios para integrar el sistema de electrificación en la mesa, de modo que el cableado quede oculto hasta su salida por la base. Se incluyen los pasacables necesarios y 3 metros de cable (midiéndolo desde el sistema de conexiones).

