

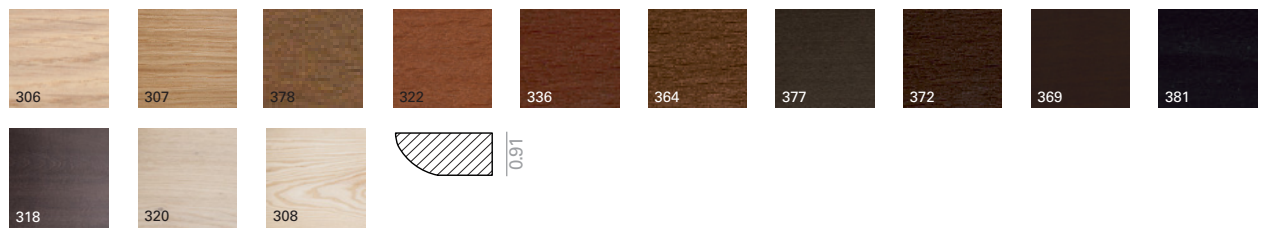

**Description**  
**Descripción**

Table with Pure Eco thermopolymer base (100% recycled) available in various colors. Round tops of different sizes available in a range of finishes.  
Mesa con base de termopolimero Pure Eco (100% reciclado) disponible en diferentes colores. Sobres redondos de diferentes medidas disponible en diferentes acabados.

**Wood finish Oak**  
**Acabado madera Roble**



**Wood lacquer finish**  
**Acabado lacas madera**



**Laminate HPL finish**  
**Acabado laminado HPL**



**Ultra-matte finish**  
**Acabado ultramate**

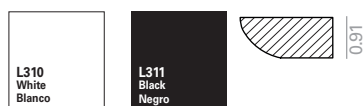

**Linoleum finish**  
**Acabado linóleo**



**Technical Stone 12 finish**  
**Acabado Technical Stone 12**

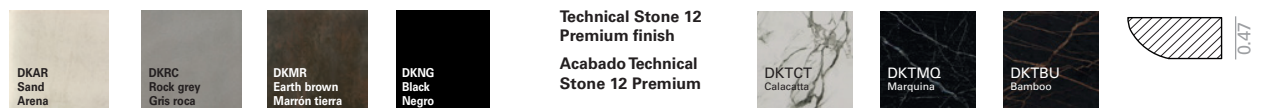

**M1 marble finish**  
**Acabado de mármol M1**



**M3 marble finish**  
**Acabado de mármol M3**



**Pure Eco Thermo-polymer finish**  
**Acabado de Termopolimero Pure Eco**



**Glass finish**  
**Acabado de cristal**



**Cement finish**  
**Acabado cemento**



**Intellectual property Propiedad intelectual**

All our collections are protected by international industrial design registries, designs patents, copyrights and intellectual Property laws. Unauthorized use of AW International Property is a criminal offence and can lead to prosecution.  
Todas nuestras colecciones están protegidas por registros de diseño industrial, diseño de patente, copyright y derechos de propiedad intelectual todo el mundo. El uso no autorizado de los diseños y propiedad intelectual de AW supone un delito que puede ser sometido a acción judicial.



## ME06100

31.50 x 31.50/Ø31.50

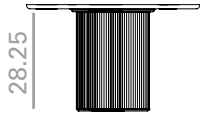
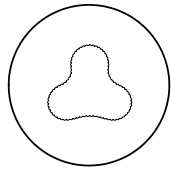

Top shape

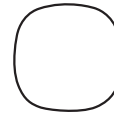

Ellipse



Round square

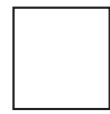

Square

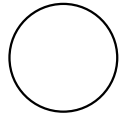

Round

	Table top / Sobre					
	*Oak Roble	Lacquered Lacado	Laminate HPL Laminado HPL	Ultra-matte Ultramate	***M1 Marble Mármol M1	***M3 Marble Mármol M3
	\$	\$	\$	\$	\$	\$
	1,389	1,122	1,427	1,559	4,149	5,482
lbs	162	162	162	162	162	81
<b>2 boxes / bultos</b> Ft	19'25	19'25	19'25	19'25	19'25	10'25

	Table top / Sobre				Top & Base
	Linoleum Linóleo	Low Iron Glass Cristal óptico	Technical Stone 12	Technical Stone 12 Premium	Cement Cemento
	\$	\$	\$	\$	\$
	1,875	1,668	2,691	3,066	2,051
lbs	162	162	0	0	162
<b>2 boxes / bultos</b> Ft	19'25	19'25	0	0	19'25

SERIE 600

\*Matte lacquered and premium upcharge

\*Incremento por lacado mate y premium

| 176 |

\*\*\*Marble shiny upcharge

Incremento por mármol brillo

| 64 |

ME06101

35.50 x 35.50/Ø35.50

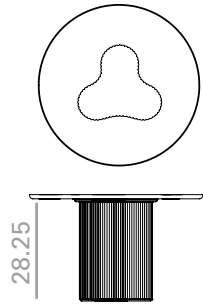

Top shape

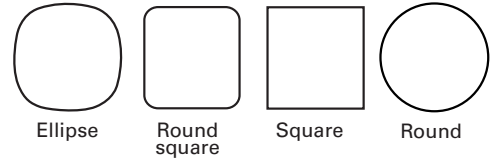

	Table top / Sobre					
	*Oak Roble	Lacquered Lacado	Laminate HPL Laminado HPL	Ultra-matte Ultramate	***M1 Marble Mármol M1	***M3 Marble Mármol M3
	\$	\$	\$	\$	\$	\$
	1,535	1,208	1,548	1,630	4,585	6,271
lbs	169	169	169	169	169	169
<b>2 boxes / bultos</b> Ft	21	21	21	21	21	21

	Table top / Sobre				Top & Base
	Linoleum Linóleo	Low Iron Glass Cristal óptico	Technical Stone 12	Technical Stone 12 Premium	Cement Cemento
	\$	\$	\$	\$	\$
	1,969	1,870	3,076	3,530	2,143
lbs	169	169	0	0	169
<b>2 boxes / bultos</b> Ft	21	21	0	0	21

SERIE 600

\*Matte lacquered and premium upcharge  
\*Incremento por lacado mate y premium

192

\*\*\*Marble shiny upcharge  
Incremento por mármol brillo

64

ME06102

39.50 x 39.50/Ø39.50

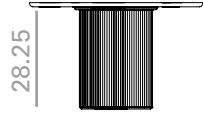
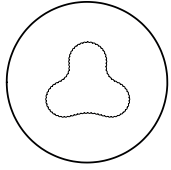

Top shape

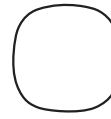

Ellipse



Round square



Square

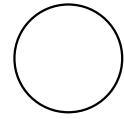

Round

	Table top / Sobre					
	*Oak Roble	Lacquered Lacado	Laminate HPL Laminado HPL	Ultra-matte Ultramate	***M1 Marble Mármol M1	***M3 Marble Mármol M3
	\$	\$	\$	\$	\$	\$
	1,666	1,285	1,655	1,705	5,030	7,109
<b>lbs</b>	169	169	169	169	169	169
<b>2 boxes / bultos</b> <b>Ft</b>	23'5	23'5	23'5	23'5	23'5	23'5

	Table top / Sobre				Top & Base
	Linoleum Linóleo	Low Iron Glass Cristal óptico	Technical Stone 12	Technical Stone 12 Premium	Cement Cemento
	\$	\$	\$	\$	\$
	2,186	2,311	3,635	4,177	2,223
<b>lbs</b>	169	169	0	0	169
<b>2 boxes / bultos</b> <b>Ft</b>	23'5	23'5	0	0	23'5

SERIE 600

\*Matte lacquered and premium upcharge  
\*Incremento por lacado mate y premium

206

\*\*\*Marble shiny upcharge  
Incremento por mármol brillo

64

**PS-IN SURFACE**

Ø2.00



**PS0804**      250

**PS-QI**

Ø7.00



**PS0714**      530

**PS-UNDERTOP**

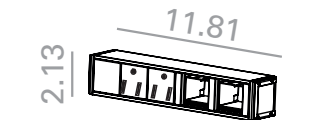

**PS0755**      1,122

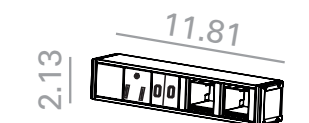

**PS0750**      1,279



**PS0756**      1,372

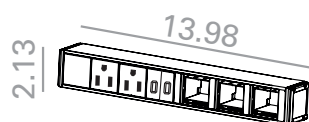

**PS0751**      1,503

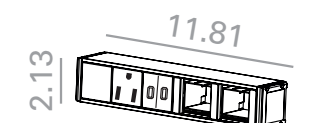

**PS0896**      589

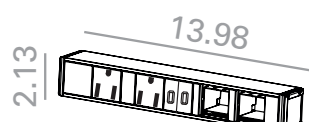

**PS0897**      937

**SOCKET TOWER TORRE DE CONEXIONES**

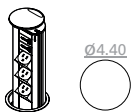

Ø4.40

**PS0799**      971



Ø4.40

**PS0800**      901

**PS-GROMMET 60**

Ø2.35



331

**PS-GROMMET 80**

Ø3.15



230

**PS-SNAKE**



312

**Preinstalled (Optional) / Preinstalación (Opcional) IN0006**

First installation / Primera instalación	<u>549</u>
Second and more installations / Segunda y más instalaciones	<u>193</u>

**IN-SURFACE POWER BOXES  
CAJAS DE CONEXIONES DENTRO DEL SOBRE**

Compact and individual charging system with 5v and 2A of power can charge any brand of mobile phones, the ports will be A + C. Available in two finishes: black or white.

Sistema de carga compacto e individual con 5v y 2A de potencia puede cargar teléfonos móviles de cualquier marca, los puertos serán A + C. Disponible en dos acabados: negro o blanco

**PS0804**



USB charger A+C

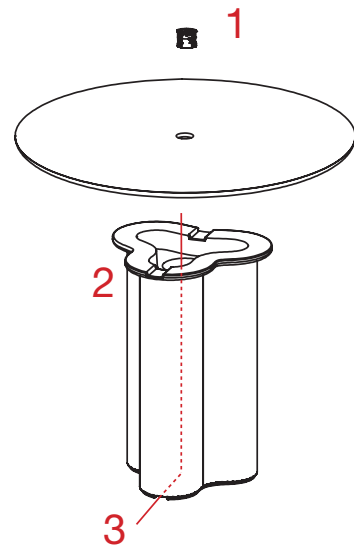

**1 POWER BOXES DISTRIBUTION DISTRIBUCIÓN DE SISTEMAS**

By standard, the position of the system will be in the central of the table, placed horizontally. When there are two system boxes, these will be separated 1/3 between them and placed horizontally.

De serie, la disposición del sistema será en el centro de la mesa y en sentido longitudinal. Cuando se disponga de dos sistemas, estos se colocarán con una separación de 1/3 de la longitud total de la mesa, y en sentido longitudinal.

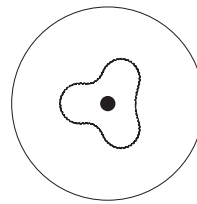

**2 WIRING MANAGEMENT GESTIÓN DEL CABLEADO**

The cable passes through an aluminum wire manager, keeping it hidden from the users.

El cable pasa a través de un perfil de aluminio que lo mantiene oculto.

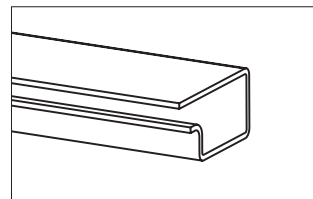

**OPTIONAL PREINSTALLED WIRING  
PREINSTALACIÓN DEL CABLEADO**

**IN0006**

Preinstalled wiring consists in the addition of the necessary mechanisms to integrate power systems in the table, so that wiring is hidden until the way out in the door. Necessary grommet are included and 3m cable (from the power system).

La preinstalación consiste en el montaje de los mecanismos necesarios para integrar el sistema de electricación en la mesa, de modo que el cableado quede oculto hasta su salida por la base. Se incluyen los pasacables necesarios y 3 metros de cable (midiendo desde el sistema de conexiones).

**3 CABLE WAY OUT SALIDA DE CABLEADO**

The cable way out can be performed directly from the leg itself through a hole in the lower part.

La salida del cable se realiza directamente desde la pata por un hueco realizado en la parte inferior.

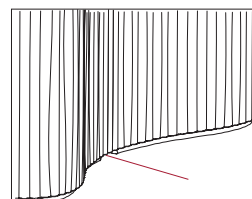

**QI CHARGING POWER BOXES  
CAJAS DE CONEXIONES QI**

The inductive charging station allows us to charge any device that has Qi technology built in. With a wide charging surface, just leave the device centered over the corresponding area. Available in black finish.

La estación de carga inductiva nos permite cargar cualquier dispositivo que tenga la tecnología Qi incorporada. Con una superficie de carga amplia, solo se debe dejar el dispositivo centrado sobre el area correspondiente. Dsponible en acabado negro.

**PS0714**

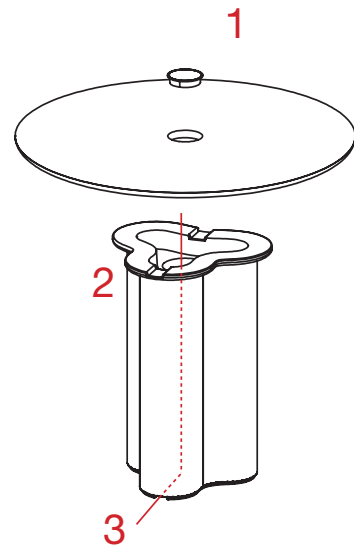

**1 POWER BOXES DISTRIBUTION DISTRIBUCIÓN DE SISTEMAS**

By standard, the position of the system will be in the central of the table, placed horizontally. When there are two system boxes, these will be separated 1/3 between them and placed horizontally.

De serie, la disposición del sistema será en el centro de la mesa y en sentido longitudinal. Cuando se disponga de dos sistemas, estos se colocarán con una separación de 1/3 de la longitud total de la mesa, y en sentido longitudinal.

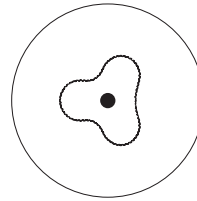

**2 WIRING MANAGEMENT GESTIÓN DEL CABLEADO**

The cable passes through an aluminum wire manager, keeping it hidden from the users.

El cable pasa a través de un perfil de aluminio que lo mantiene oculto.

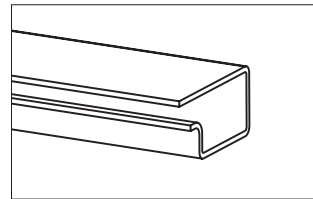

**OPTIONAL PREINSTALLED WIRING  
PREINSTALACIÓN DEL CABLEADO**

**IN0006**

Preinstalled wiring consists in the addition of the necessary mechanisms to integrate power systems in the table, so that wiring is hidden until the way out in the door. Necessary grommet are included and 3m cable (from the power system).

La preinstalación consiste en el montaje de los mecanismos necesarios para integrar el sistema de electricación en la mesa, de modo que el cableado quede oculto hasta su salida por la base. Se incluyen los pasacables necesarios y 3 metros de cable (midiendo desde el sistema de conexiones).

**3 CABLE WAY OUT SALIDA DE CABLEADO**

The cable way out can be performed directly from the leg itself through a hole in the lower part.

La salida del cable se realiza directamente desde la pata por un hueco realizado en la parte inferior.

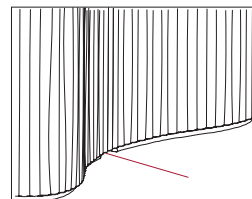

**UNDER-TOP POWER BOXES  
CAJA DE CONEXIONES BAJO EL SOBRE**

Power box mounted under the table top. Available in black. There are two power system sizes available and data slots can be customized according to the below diagram.

Regleta de conexiones bajo la superficie del sobre. Se sirve en color negro. Se ofrecen formatos de caja de dos tamaños de caja diferentes y con opciones de conectividad configurable.

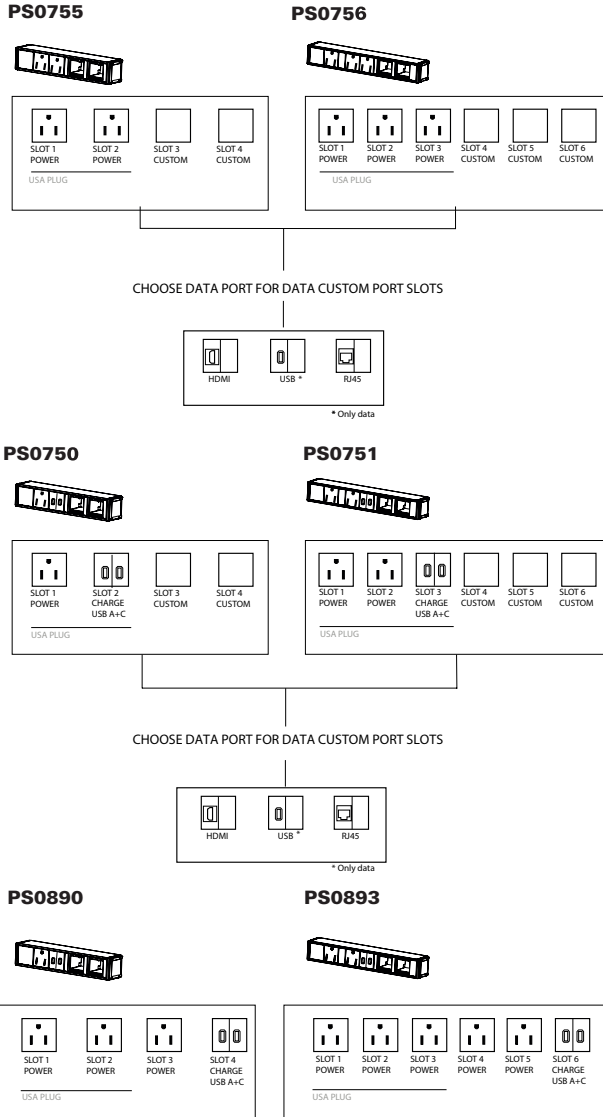

**OPTIONAL PREINSTALLED WIRING  
PREINSTALACIÓN DEL CABLEADO**

**IN0006**

Preinstalled wiring consists in the addition of the necessary mechanisms to integrate power systems in the table, so that wiring is hidden until the way out in the door. Necessary grommet are included and 3m cable (from the power system).

La preinstalación consiste en el montaje de los mecanismos necesarios para integrar el sistema de electricación en la mesa, de modo que el cableado quede oculto hasta su salida por la base. Se incluyen los pasacables necesarios y 3 metros de cable (midiéndolo desde el sistema de conexiones).

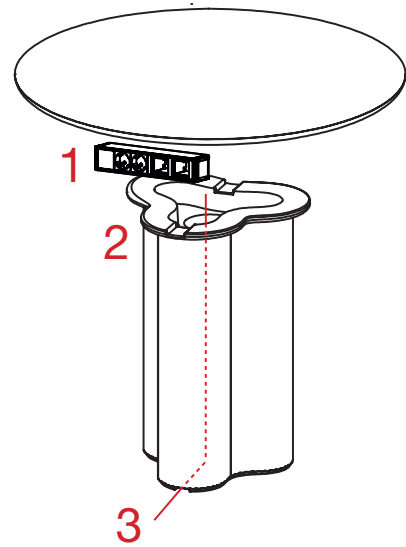

**1 POWER BOXES DISTRIBUTION DISTRIBUCIÓN DE SISTEMAS**

By standard, the arrangement of the system will be in the center of the long side of the table, in longitudinal direction and at 75 mm from the edge.

De serie, la disposición del sistema será en el centro del lado largo de la mesa, en sentido longitudinal y a 75 mm del canto.

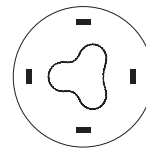

**2 WIRING MANAGEMENT GESTIÓN DEL CABLEADO**

The cable passes through an aluminum wire manager, keeping it hidden from the users.

El cable pasa a través de un perfil de aluminio que lo mantiene oculto.

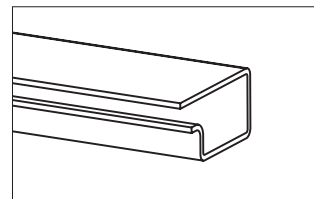

**3 CABLE WAY OUT SALIDA DE CABLEADO**

The cable way out can be performed directly from the leg itself through a hole in the lower part.

La salida del cable se realiza directamente desde la pata por un hueco realizado en la parte inferior.

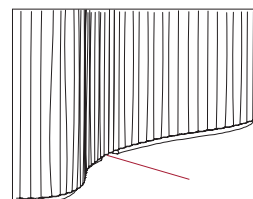



## IN-SURFACE SOCKET POWERS TORRES DE CONEXIONES DENTRO DEL SOBRE

Socket tower mounted in the table top. The hidden system manually rises with a slight push. Valid for Reverse tables with bases Reverse 38, 50 and 60. Available in silver, white or black color, for for other finishing, contact the Customer Department.

Torre de conexiones integrada dentro de la superficie del sobre. El sistema eléctrico oculto se alza manualmente al pulsarlo. Disponible mesas Reverse con bases Reverse 38, 50 y 60. Disponible en color plata, blanco o negro, para otros acabados consultar a

### PS0799

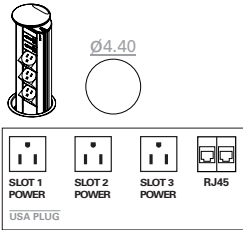

### PS0800

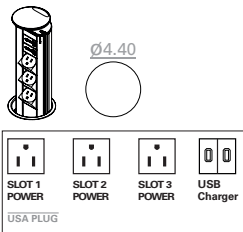

## OPTIONAL PREINSTALLED WIRING PREINSTALACIÓN DEL CABLEADO

### IN0006

Preinstalled wiring consists in the addition of the necessary mechanisms to integrate power systems in the table, so that wiring is hidden until the way out in the door. Necessary grommet are included and 3m cable (from the power system).

La preinstalación consiste en el montaje de los mecanismos necesarios para integrar el sistema de electricidad en la mesa, de modo que el cableado quede oculto hasta su salida por la base. Se incluyen los pasacables necesarios y 3 metros de cable (midiendo desde el sistema de conexiones).

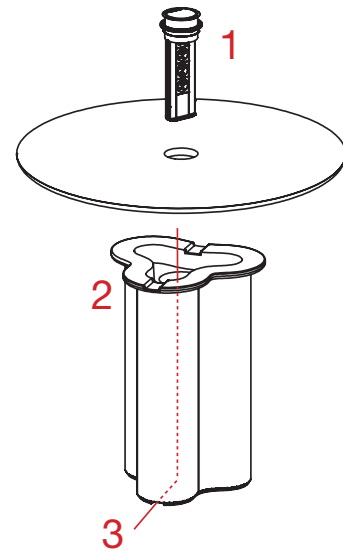

## 1 POWER BOXES DISTRIBUTION DISTRIBUCIÓN DE SISTEMAS

By standard, the arrangement of the system will be in the center of the table, with 2 systems the position will be centered on the longitudinal axis at a distance of 320 mm from the center of the table.

De serie, la disposición del sistema será en el centro de la mesa, con 2 sistemas la posición sera centrado en el eje longitudinal a una distancia de 320 mm del centro de la mesa.

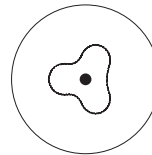

## 2 WIRING MANAGEMENT GESTIÓN DEL CABLEADO

The cable passes through an aluminum wire manager, keeping it hidden from the users.

El cable pasa a través de un perfil de aluminio que lo mantiene oculto.

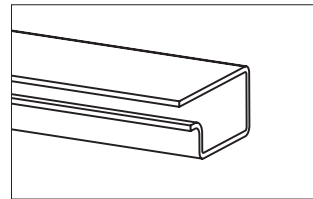

## 3 CABLE WAY OUT SALIDA DE CABLEADO

The cable way out can be performed directly from the leg itself through a hole in the lower part.

La salida del cable se realiza directamente desde la pata por un hueco realizado en la parte inferior.

